

SMD ISOLATOR

[P/N : IL05AL(R)1880AAE]

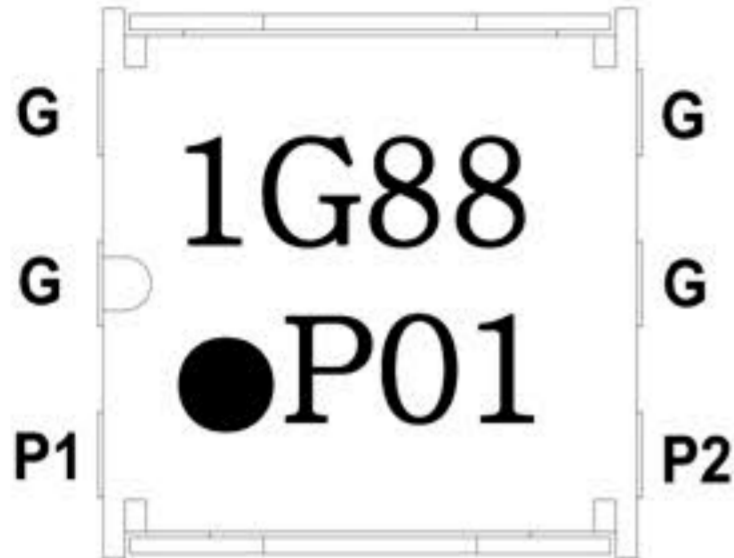

P1,P2 : IN/OUT Port
G : Ground
1G88 : 1880MHz[fc]
●P01 :
●P01 L type [signal flow direction P1 → P2]
P01● R type [signal flow direction P2 → P1]
 [or left side dot is L type,
 right side dot is R type]

0 Year [2010]
1 Month [January]
 (Oct,Nov,Dec denoted as **O,N,D**)

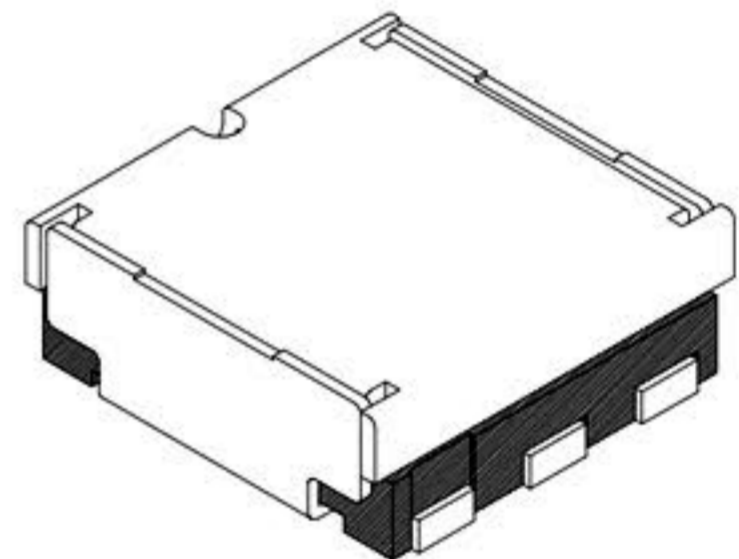
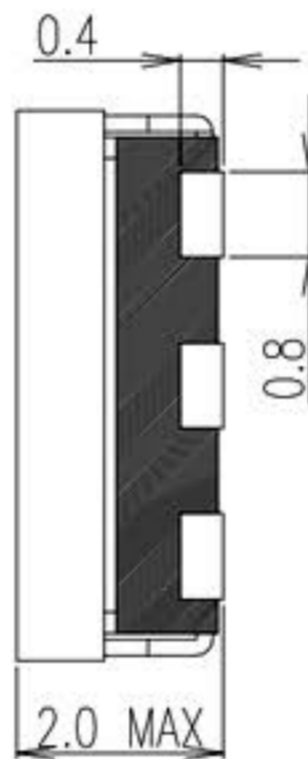
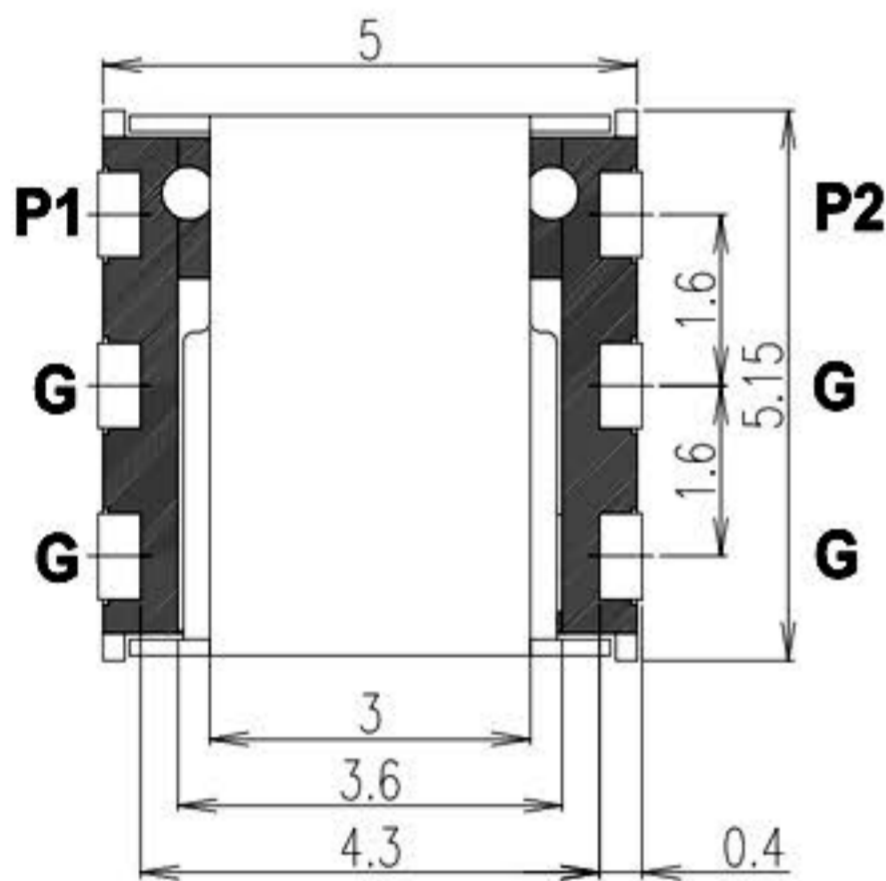

Scale : N/S
 Unit : mm
 Tolerance : ±0.2

ELECTRICAL SPECIFICATION	
Frequency Range	1850 ~ 1910 MHz
Operating Temp.	-35 ~ +85 °C
Insertion Loss	0.6 dB max.
Isolation	15 dB min.
VSWR	1.5 max.
Forward Power	10 W max.
Reverse Power	2 W max.

PART NUMBERING	
IL 05 A L(R) 1880 AA E	
IL	: Isolator Group
05	: Size [5*5*2.0t]
A	: Fabrication condition
L(R)	: Signal direction
1880	: Center frequency [1880MHz]
AA	: Fabrication condition
E	: Embossed plastic reel
* RoHS Compliant(Lead Free)	
- Ver 2.0 (2012.01.02.)	