



KBL4005 THRU KBL410

Reverse Voltage - 50 to 1000 V olts Forward Current - 4.0 Amperes

SILICON BRIDGE RECTIFIERS

Features

- ◆ The plastic package carries Underwriters Laboratory Flammability Classification 94V-0
- ◆ Ideal for printed circuit boards
- ◆ Low reverse leakage
- ◆ High forward surge current capability
- ◆ High temperature soldering guaranteed:
260°C/10 seconds, 0.375" (9.5mm) lead length, 5 lbs. (2.3kg) tension

Mechanical Data

Case : JEDEC KBL Molded plastic body

Terminals : Solder plated, solderable per MIL-STD-750, Method 2026

Polarity : Polarity symbol marking on body

Mounting Position : Any

Weight : 0.22 ounce , 6.21 grams

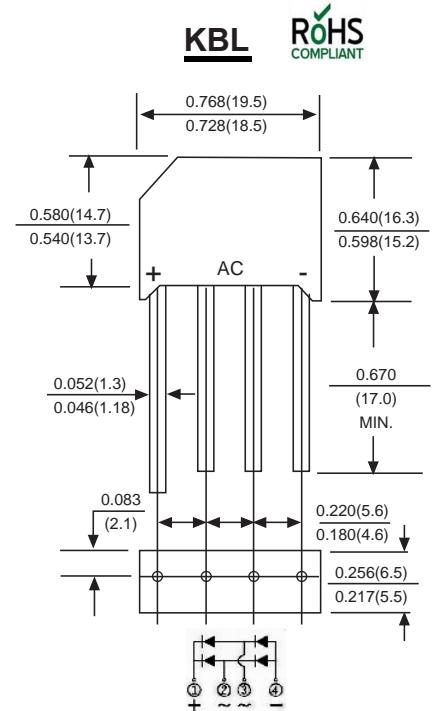

Dimensions in inches and (millimeters)

Maximum Ratings And Electrical Characteristics

Ratings at 25°C ambient temperature unless otherwise specified.

Single phase half-wave 60Hz, resistive or inductive load, for capacitive load current derate by 20%.

Parameter	SYMBOLS	MDD	MDD	MDD	MDD	MDD	MDD	MDD	UNITS	
		KBL4005	KBL401	KBL402	KBL404	KBL406	KBL408	KBL410		
Marking Code										
Maximum repetitive peak reverse voltage	V_{RRM}	50	100	200	400	600	800	1000	V	
Maximum RMS voltage	V_{RMS}	35	70	140	280	420	560	700	V	
Maximum DC blocking voltage	V_{DC}	50	100	200	400	600	800	1000	V	
Maximum average forward output rectified current at $T_c=50^\circ\text{C}$ (Note 2) $T_A=50^\circ\text{C}$ (Note 3)	I_{AV}					4.0				A
Peak forward surge current 8.3ms single half sine-wave superimposed on rated load (JEDEC Method)	I_{FSM}					125				A
Rating for Fusing ($t < 8.3\text{ms}$)	I^2t					166				A ² s
Maximum instantaneous forward voltage drop per bridge element at 4.0A	V_F					1.0				V
Maximum DC reverse current at rated DC blocking voltage $T_A=25^\circ\text{C}$ $T_A=100^\circ\text{C}$	I_R					10				μA
						1.0				mA
Typical Junction Capacitance (Note 1)	C_J					105				pF
Typical Thermal Resistance (Note 2)	$R_{\theta JA}$					20				$^\circ\text{C}/\text{W}$
Operating junction temperature range	T_J					-65 to +150				$^\circ\text{C}$
storage temperature range	T_{STG}					-55 to +150				$^\circ\text{C}$

NOTES:

1. Measured at 1.0 MHz and applied reverse voltage of 4.0 Volts.
2. Unit mounted on 3.0" x 3.0" x 0.11" thick (7.5x7.5x0.3cm) Al. plate.
3. P.C. Board mounted with 0.5" x 0.5" (12x12mm) copper pads, 0.375" (9.5mm) lead length.



KBL4005 THRU KBL410

Reverse Voltage - 50 to 1000 V olts Forward Current - 4.0 Amperes

Ratings And Characteristic Curves

AVERAGE FORWARD RECTIFIED CURRENT, AMPERES

FIG. 1- FORWARD CURRENT DERATING CURVE

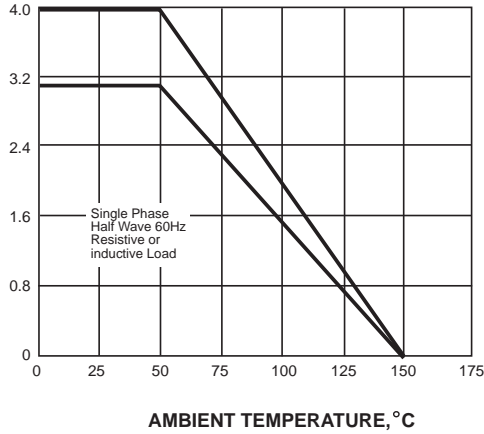

PEAK FORWARD SURGE CURRENT, AMPERES

FIG. 2-MAXIMUM NON-REPETITIVE PEAK FORWARD SURGE CURRENT

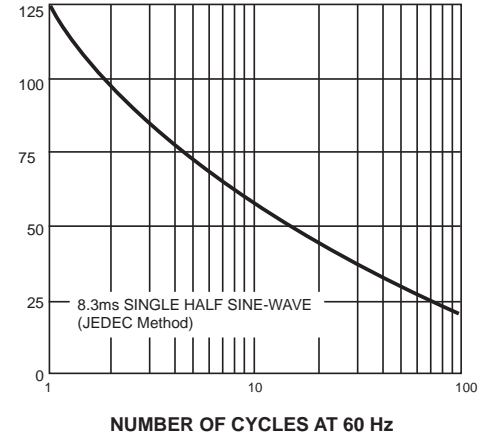
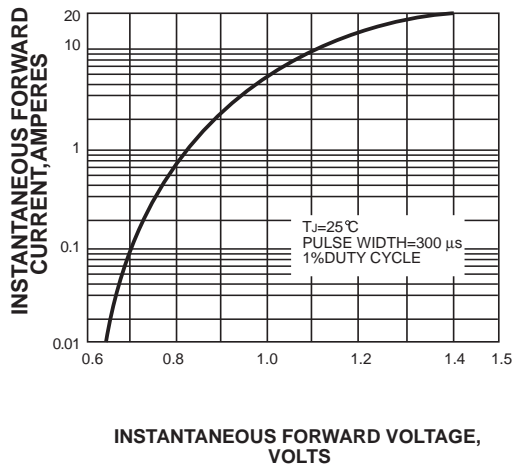

FIG. 3-TYPICAL INSTANTANEOUS FORWARD CHARACTERISTICS



INSTANTANEOUS REVERSE CURRENT, MICROAMPERES

FIG. 4-TYPICAL REVERSE CHARACTERISTICS

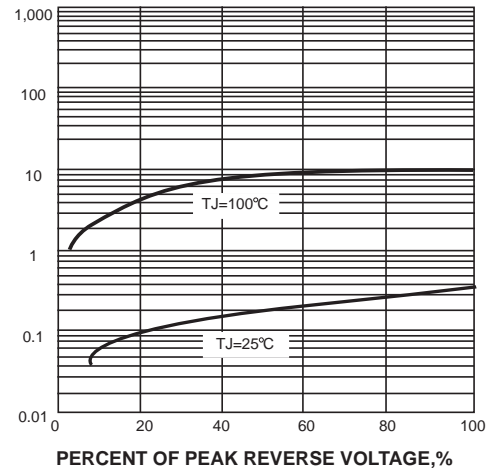
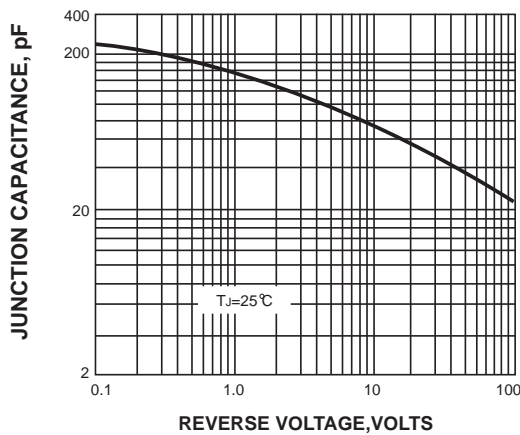
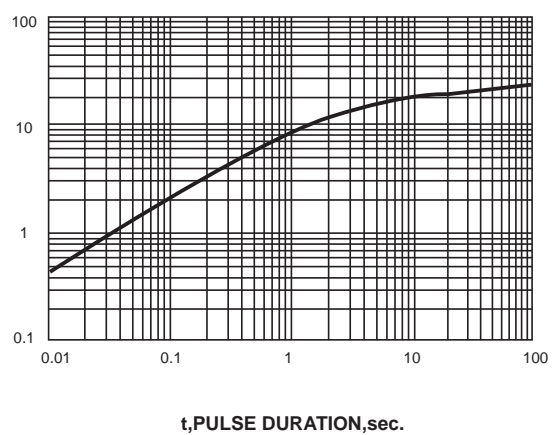

FIG. 5-TYPICAL JUNCTION CAPACITANCE



TRANSIENT THERMAL IMPEDANCE, °C/W

FIG. 6-TYPICAL TRANSIENT THERMAL IMPEDANCE



The curve above is for reference only.



KBL4005 THRU KBL410

Reverse Voltage - 50 to 1000 V olts Forward Current - 4.0 Amperes

Packing information

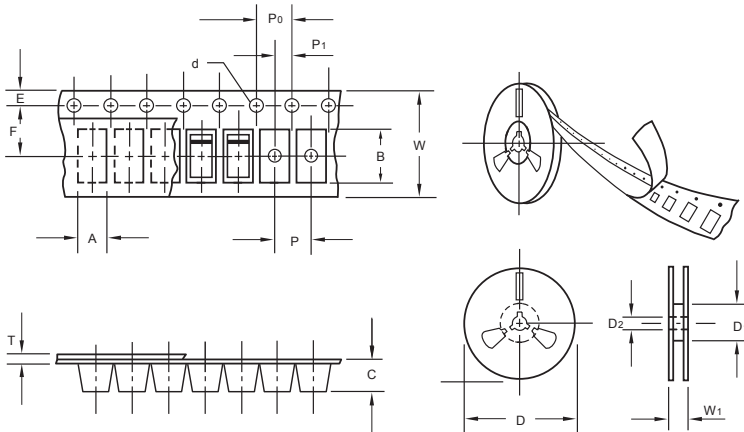

unit:mm

Item	Symbol	Tolerance	ABS
Carrier width	A	0.1	5.45
Carrier length	B	0.1	7.00
Carrier depth	C	0.1	1.60
Sprocket hole	d	0.05	1.55
13" Reel outside diameter	D	2.0	330.00
13" Reel inner diameter	D ₁	min	50.00
Feed hole diameter	D ₂	0.5	13.00
Sprocket hole position	E	0.1	1.75
Punch hole position	F	0.1	5.50
Punch hole pitch	P	0.1	8.00
Sprocket hole pitch	P ₀	0.1	4.00
Embossment center	P ₁	0.1	2.00
Overall tape thickness	T	0.1	0.25
Tape width	W	0.3	12.00
Reel width	W ₁	1.0	12.40

Note: Devices are packed in accordance with EIA standard RS-481-A and specifications listed above.

Reel packing

PACKAGE	REEL SIZE	REEL (pcs)	COMPONENT SPACING (mm)	BOX (pcs)	INNER BOX (mm)	REEL DIA, (mm)	CARTON SIZE (mm)	CARTON (pcs)	APPROX. GROSS WEIGHT (kg)
ABS	13"	3,000	4.0	6000	xxx*XXX*XX	330	360*360*360	48000	11.0

Suggested Pad Layout

Important Notice and Disclaimer

Microdiode Electronics (Jiangsu) reserves the right to make changes to this document and its products and specifications at any time without notice. Customers should obtain and confirm the latest product information and specifications before final design, purchase or use.

Microdiode Electronics (Jiangsu) makes no warranty, representation or guarantee regarding the suitability of its products for any particular purpose, nor does Microdiode Electronics (Jiangsu) assume any liability for application assistance or customer product design. Microdiode Electronics (Jiangsu) does not warrant or accept any liability with products which are purchased or used for any unintended or unauthorized application.

No license is granted by implication or otherwise under any intellectual property rights of Microdiode Electronics (Jiangsu).

Microdiode Electronics (Jiangsu) products are not authorized for use as critical components in life support devices or systems without express written approval of Microdiode Electronics (Jiangsu).