

# CERAMIC CHIP INDUCTORS

**OPERATION TEMP.** -25~+85°C (Including self-generated heat)

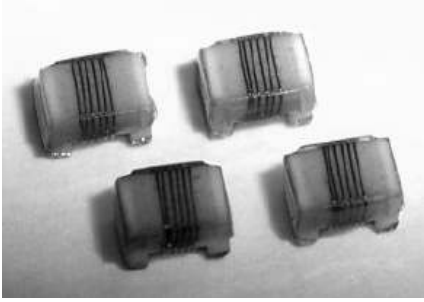

## FEATURES

ABC0 chip inductor is wire wound type ceramic inductor. And our product provide high Q value. So ABC0 chip inductor can be SRF(self resonant frequency)industry. This can often eliminate the need for variable components in tuned circuits and ocllators. With our engineering and manufacturing facilities, we're able to quickly provide tailored to your needs.

## APPLICATION

RF circuits for mobile phone, digital tuners, car-navigations, pagers and other communication devices.

## DIMENSIONS

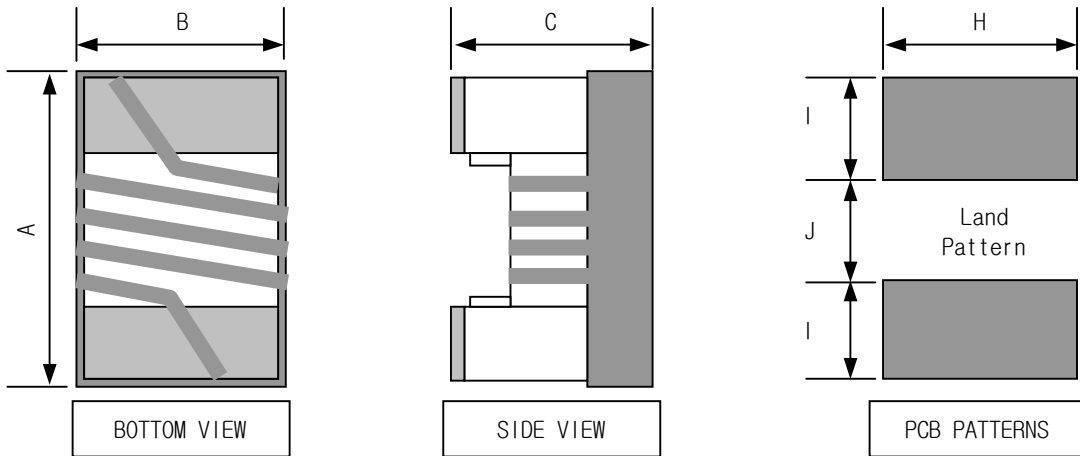

Unit : mm

SYMBOL		2012TYPE	1608TYPE	1005TYPE
BOTTOM VIEW	A	2.25±0.1	1.65±0.1	1.05±0.1
	B	1.60±0.1	1.05±0.1	0.55±0.1
SIDE VIEW	C	1.40±0.1	0.90±0.1	0.50±0.1
PCB PATTERNS	H	1.78	1.02	0.66
	I	1.02	0.64	0.36
	J	0.76	0.64	0.46

## ■ TAPE & REEL SPECIFICATIONS

### ● TAPE DIMENSIONS

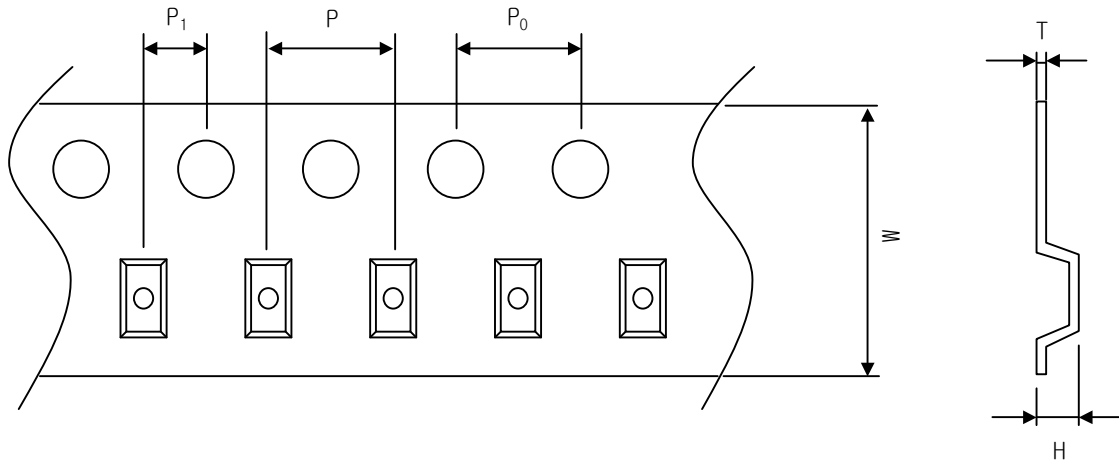

Unit : mm

SYMBOL		2012	1608	1005
TAPE DIMENSIONS	W	$8 \pm 0.2$	$8 \pm 0.1$	$8 \pm 0.2$
	P	$4 \pm 0.1$	$4 \pm 0.1$	$2 \pm 0.05$
	P <sub>0</sub>	$4 \pm 0.1$	$4 \pm 0.1$	$4 \pm 0.1$
	P <sub>1</sub>	$2 \pm 0.05$	$2 \pm 0.05$	$2 \pm 0.05$
	H	$1.5^{+0.09}_{-0}$	-	-
	T	$0.30 \pm 0.02$	$0.95 \pm 0.05$	$0.68 \pm 0.03$

### ● REEL DIMENSIONS

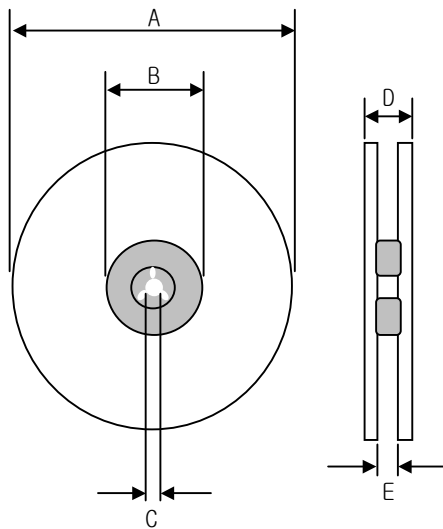

Unit : mm

SYMBOL		2012	1608	1005
REEL DIMENSIONS	A	180	180	180
	B	60	105	105
	C	13	13	13
	D	14.4	14.4	14.4
	E	8.4	8.4	8.4
PER REEL (Q' ty)		2,000	3,000	4,000

# ITEM PART NUMBERS

LMC 2012 HIGH-Q						
Ordering code <sup>1</sup>	Inductance <sup>2</sup> [nH]	Tolerance <sup>3</sup> (%)	Q <sup>4</sup> (min.)	SRF Min. <sup>5</sup> (MHZ)	Rdc Max. <sup>6</sup> ( $\Omega$ )	Idc Max. <sup>7</sup> (mA)
LMC2012 TQ-2N7K	2.7 @ 250MHZ	$\pm 10,5,2$	80 @ 1500MHZ	6000	0.020	1600
LMC2012 TQ-5N6K	5.6 @ 250MHZ	$\pm 10,5,2$	98 @ 1500MHZ	6000	0.035	1600
LMC2012 TQ-6N2K	6.2 @ 250MHZ	$\pm 10,5,2$	88 @ 1000MHZ	4750	0.035	1600
LMC2012 TQ-120K	12 @ 250MHZ	$\pm 10,5,2$	80 @ 1000MHZ	3000	0.045	1600
LMC2012 TQ-160K	16 @ 250MHZ	$\pm 10,5,2$	72 @ 500MHZ	2950	0.060	1500
LMC2012 TQ-165K	16.5 @ 250MHZ	$\pm 10,5,2$	65 @ 500MHZ	2850	0.060	1400
LMC2012 TQ-180K	18 @ 250MHZ	$\pm 10,5,2$	75 @ 500MHZ	2550	0.060	1400
LMC2012 TQ-200K	20 @ 250MHZ	$\pm 10,5,2$	70 @ 500MHZ	2050	0.055	1400
LMC2012 TQ-270K	27 @ 250MHZ	$\pm 10,5,2$	75 @ 500MHZ	2000	0.070	1300
LMC2012 TQ-300K	30 @ 250MHZ	$\pm 10,5,2$	65 @ 500MHZ	1950	0.095	1200
LMC2012 TQ-390K	39 @ 250MHZ	$\pm 10,5,2$	65 @ 500MHZ	1600	0.110	1100
LMC2012 TQ-470K	47 @ 250MHZ	$\pm 10,5,2$	65 @ 500MHZ	1400	0.095	1200
LMC2012 TQ-510K	51 @ 250MHZ	$\pm 10,5,2$	65 @ 500MHZ	1400	0.120	1000
LMC2012 TQ-560K	56 @ 200MHZ	$\pm 10,5,2$	65 @ 500MHZ	1300	0.150	900
LMC2012 TQ-820K	82 @ 150MHZ	$\pm 10,5,2$	65 @ 500MHZ	1000	0.220	800

1.How to order

**LM C 2012 T Q 3N3 K**  
 (1) (2) (3) (4) (5) (6) (7)

2. Inductance measured:RF LCR METER(HP4286A)+16193A fixture

3.G= $\pm 2\%$ ,J= $\pm 5\%$ ,K= $\pm 10\%$

4.Q measured:RF LCR METER(HP4286A)+16193A fixture

5.SRF measured:network analyzer(HP8753D)+ABCO SMD-D test fixture

6.Rdc measured:RF LCR METER(HP4286A)+16193A fixture

7.Idc measured:For 15°C Rise

(1)Series name (2)Material

(3)Body size (4)T:Taping

(5)Q:High Q

(6)Inductance Value

Ex:3N3(3.3nH),560(56nH),391(390nH)

(7)Inductance Tol.

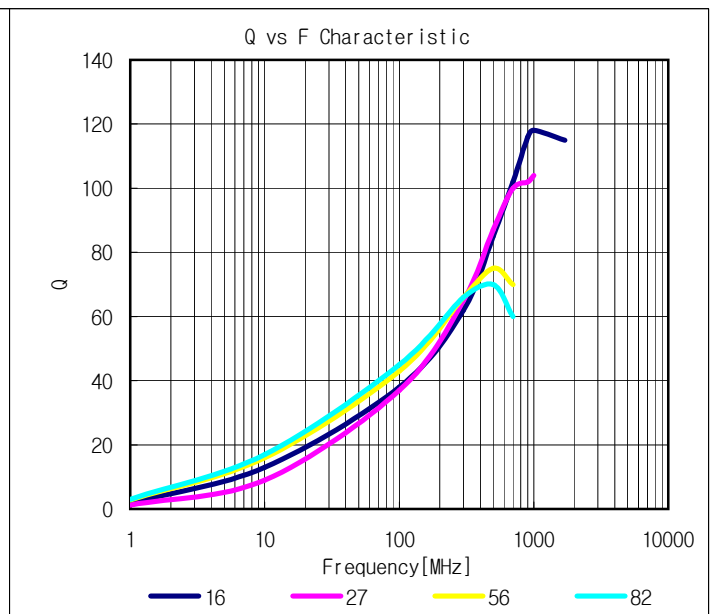
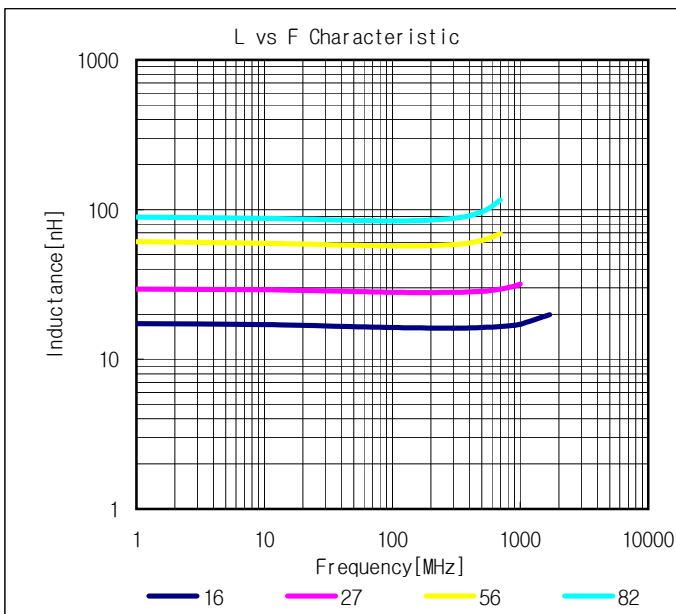

# ITEM PART NUMBERS

LMC2012						
Odering code <sup>1</sup>	Inductance <sup>2</sup> [nH]	Tolerance <sup>3</sup> (%)	Q <sup>4</sup> (min.)	SRF Min. <sup>5</sup> (MHZ)	Rdc Max. <sup>6</sup> ( $\Omega$ )	Idc Max. <sup>7</sup> (mA)
LMC2012 TP 2N7K	2.7 @ 250MHZ	± 10,5	50 @ 1500MHZ	7900	0.06	800
LMC2012 TP 3N3K	3.3 @ 250MHZ	± 10,5	50 @ 1500MHZ	7900	0.08	600
LMC2012 TP 3N9K	3.9 @ 250MHZ	± 10,5	25 @ 1000MHZ	7900	0.08	600
LMC2012 TP 5N6K	5.6 @ 250MHZ	± 10,5	50 @ 1000MHZ	5500	0.08	600
LMC2012 TP 6N2K	6.2 @ 250MHZ	± 10,5	50 @ 1000MHZ	5500	0.11	600
LMC2012 TP 6N8K	6.8 @ 250MHZ	± 10,5,2	50 @ 1000MHZ	5500	0.11	600
LMC2012 TP 7N5K	7.5 @ 250MHZ	± 10,5,2	50 @ 1000MHZ	5000	0.11	600
LMC2012 TP 8N2K	8.2 @ 250MHZ	± 10,5,2	50 @ 1000MHZ	4700	0.12	600
LMC2012 TP 100K	10 @ 250MHZ	± 10,5,2	50 @ 500MHZ	4200	0.14	600
LMC2012 TP 120K	12 @ 250MHZ	± 10,5,2	50 @ 500MHZ	4000	0.15	600
LMC2012 TP 150K	15 @ 250MHZ	± 10,5,2	50 @ 500MHZ	3400	0.17	600
LMC2012 TP 160K	16 @ 250MHZ	± 10,5,2	50 @ 500MHZ	3400	0.18	600
LMC2012 TP 170K	17 @ 250MHZ	± 10,5,2	50 @ 500MHZ	3300	0.18	600
LMC2012 TP 180K	18 @ 250MHZ	± 10,5,2	50 @ 500MHZ	3300	0.20	600
LMC2012 TP 200K	20 @ 250MHZ	± 10,5,2	55 @ 500MHZ	2600	0.22	600
LMC2012 TP 220K	22 @ 250MHZ	± 10,5,2	55 @ 500MHZ	2600	0.22	500
LMC2012 TP 240K	24 @ 250MHZ	± 10,5,2	55 @ 500MHZ	2550	0.23	500
LMC2012 TP 250K	25 @ 250MHZ	± 10,5,2	55 @ 500MHZ	2600	0.22	500
LMC2012 TP 270K	27 @ 250MHZ	± 10,5,2	55 @ 500MHZ	2500	0.25	500
LMC2012 TP 300K	30 @ 250MHZ	± 10,5,2	60 @ 500MHZ	2300	0.20	500
LMC2012 TP 330K	33 @ 250MHZ	± 10,5,2	60 @ 500MHZ	2050	0.27	500
LMC2012 TP 360K	36 @ 250MHZ	± 10,5,2	60 @ 500MHZ	2050	0.27	500
LMC2012 TP 390K	39 @ 250MHZ	± 10,5,2	60 @ 500MHZ	2000	0.27	500
LMC2012 TP 430K	43 @ 200MHZ	± 10,5,2	60 @ 500MHZ	1650	0.34	500
LMC2012 TP 470K	47 @ 200MHZ	± 10,5,2	60 @ 500MHZ	1650	0.31	500
LMC2012 TP 560K	56 @ 200MHZ	± 10,5,2	60 @ 500MHZ	1550	0.34	500
LMC2012 TP 600K	60 @ 200MHZ	± 10,5,2	60 @ 500MHZ	1450	0.36	500
LMC2012 TP 620K	62 @ 200MHZ	± 10,5,2	60 @ 500MHZ	1450	0.36	500
LMC2012 TP 680K	68 @ 200MHZ	± 10,5,2	60 @ 500MHZ	1450	0.38	500
LMC2012 TP 720K	72 @ 150MHZ	± 10,5,2	60 @ 500MHZ	1450	0.40	500
LMC2012 TP 750K	75 @ 150MHZ	± 10,5,2	65 @ 500MHZ	1300	0.40	500
LMC2012 TP 820K	82 @ 150MHZ	± 10,5,2	65 @ 500MHZ	1300	0.42	400
LMC2012 TP 840K	84 @ 150MHZ	± 10,5,2	65 @ 500MHZ	1300	0.42	400
LMC2012 TP 910K	91 @ 150MHZ	± 10,5,2	65 @ 500MHZ	1250	0.44	400
LMC2012 TP 950K	95 @ 150MHZ	± 10,5,2	65 @ 500MHZ	1200	0.46	400
LMC2012 TP 101K	100 @ 150MHZ	± 10,5,2	65 @ 500MHZ	1200	0.46	400
LMC2012 TP 111K	110 @ 150MHZ	± 10,5,2	50 @ 250MHZ	1200	0.48	400
LMC2012 TP 121K	120 @ 150MHZ	± 10,5,2	50 @ 250MHZ	1100	0.51	400
LMC2012 TP 141K	140 @ 100MHZ	± 10,5,2	50 @ 250MHZ	1000	0.56	400
LMC2012 TP 151K	150 @ 100MHZ	± 10,5,2	50 @ 250MHZ	920	0.56	400
LMC2012 TP 161K	160 @ 100MHZ	± 10,5,2	50 @ 250MHZ	900	0.58	400
LMC2012 TP 181K	180 @ 100MHZ	± 10,5,2	50 @ 250MHZ	870	0.64	400
LMC2012 TP 201K	200 @ 100MHZ	± 10,5,2	50 @ 250MHZ	870	0.68	400
LMC2012 TP 221K	220 @ 100MHZ	± 10,5,2	50 @ 250MHZ	850	0.70	400
LMC2012 TP 231K	230 @ 100MHZ	± 10,5,2	44 @ 250MHZ	800	0.96	400
LMC2012 TP 241K	240 @ 100MHZ	± 10,5,2	44 @ 250MHZ	700	0.96	400
LMC2012 TP 251K	250 @ 100MHZ	± 10,5,2	44 @ 250MHZ	700	1.00	400
LMC2012 TP 271K	270 @ 100MHZ	± 10,5,2	48 @ 250MHZ	650	1.00	350
LMC2012 TP 291K	290 @ 100MHZ	± 10,5,2	48 @ 250MHZ	620	1.38	350
LMC2012 TP 301K	300 @ 100MHZ	± 10,5,2	48 @ 250MHZ	600	1.38	350

# LMC2012

Odering code <sup>1</sup>	Inductance <sup>2</sup> [nH]	Tolerance <sup>3</sup> (%)	Q <sup>4</sup> (min.)	SRF Min. <sup>5</sup> (MHZ)	Rdc Max. <sup>6</sup> (Ω)	Idc Max. <sup>7</sup> (mA)
LMC2012 TP 331K	330 @ 100MHZ	± 10,5,2	48 @ 250MHZ	600	1.40	310
LMC2012 TP 391K	390 @ 100MHZ	± 10,5,2	48 @ 250MHZ	560	1.50	290
LMC2012 TP 401K	400 @ 50MHZ	± 10,5,2	35 @ 250MHZ	500	1.60	250
LMC2012 TP 471K	470 @ 50MHZ	± 10,5,2	33 @ 100MHZ	375	1.90	230
LMC2012 TP 501K	500 @ 25MHZ	± 10,5,2	23 @ 50MHZ	350	2.00	210
LMC2012 TP 561K	560 @ 25MHZ	± 10,5,2	23 @ 50MHZ	340	2.35	180
LMC2012 TP 621K	620 @ 25MHZ	± 10,5,2	23 @ 50MHZ	280	3.30	130
LMC2012 TP 681K	680 @ 25MHZ	± 10,5,2	23 @ 50MHZ	250	3.51	120
LMC2012 TP 751K	750 @ 25MHZ	± 10,5,2	23 @ 50MHZ	220	4.80	90
LMC2012 TP 821K	820 @ 25MHZ	± 10,5,2	23 @ 50MHZ	215	4.20	80
LMC2012 TP 911K	910 @ 25MHZ	± 10,5,2	23 @ 50MHZ	200	5.60	80
LMC2012 TP 102K	1000 @ 25MHZ	± 10,5,2	23 @ 50MHZ	180	9.24	10
LMC2012 TP 122K	1200 @ 25MHZ	± 10,5,2	23 @ 50MHZ	180	9.24	10

1.How to order

**LM C 2012 TP 3N3 K**  
 (1) (2) (3) (4) (5) (6)

- (1)Part name
- (2)Material
- (3)Body size
- (4)TP:Taping
- (5)Inductance Value  
Ex:3N3(3.3nH),560(56nH),391(390nH)
- (6)Inductance Tol.

2.Inductance measured:RF LCR METER(HP4286A)+16193A fixture

3.G=±2%,J=±5%,K=±10%

4.Q measured:RF LCR METER(HP4286A)+16193A fixture

5.SRF measured:network analyzer(HP8753D)+ABCO SMD-D test fixture

6.Rdc measured:RF LCR METER(HP4286A)+16193A fixture

7.Idc measured:For 15°C Rise

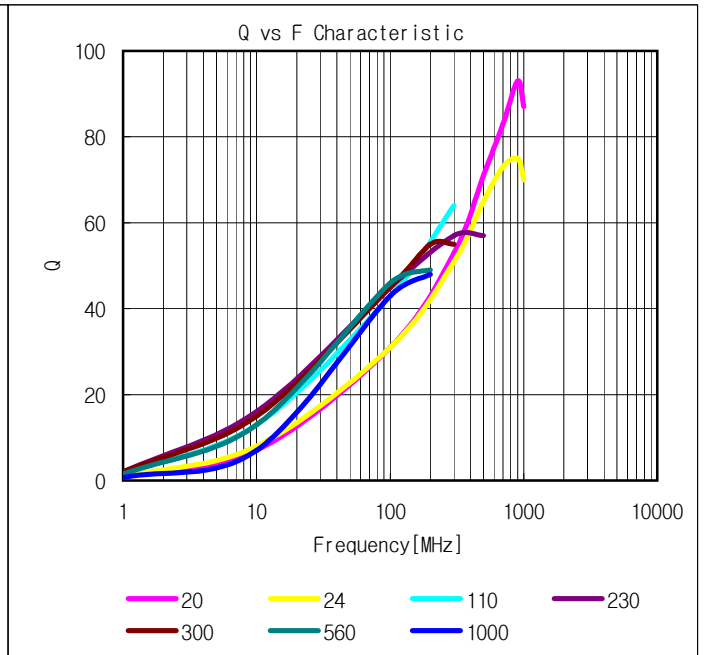
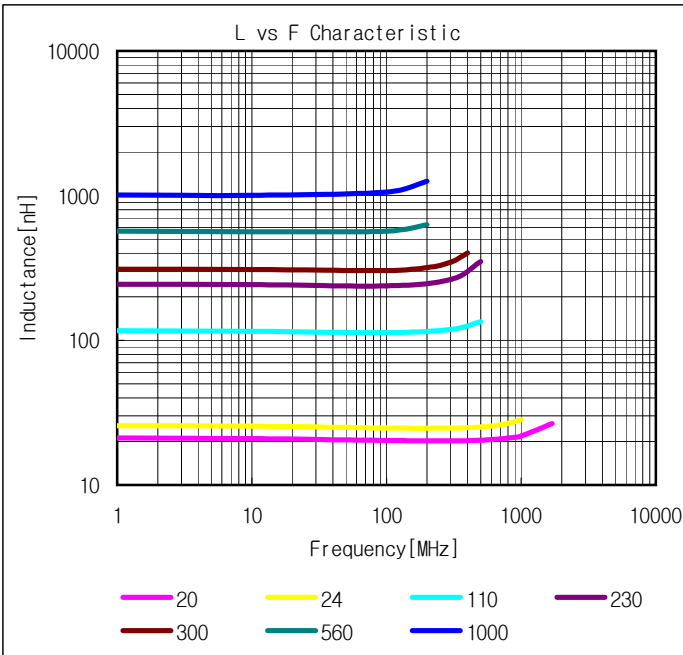

# ITEM PART NUMBERS

LMC1608										
Ordering code <sup>1</sup>	Inductance <sup>2</sup> [nH]	Tolerance <sup>3</sup> (%)	Q <sup>4</sup> (min.)	SRF Min. <sup>5</sup> (MHZ)	Rdc Max. <sup>6</sup> ( $\Omega$ )	Idc Max. <sup>7</sup> (mA)	900MHz		1.7GHz	
							L Typ	Q typ	L Typ	Q typ
LMC1608TP 1N5K	1.5@ 250MHZ	± 10,5	26	12500	0.04	700	1.59	52	1.62	93
LMC1608TP 1N6K	1.6@ 250MHZ	± 10,5	24	12500	0.03	700	1.67	49	1.65	63
LMC1608TP 1N8K	1.8@ 250MHZ	± 10,5	16	12500	0.05	700	1.63	35	1.66	50
LMC1608TP 2N2K	2.2@ 250MHZ	± 10,5	10	12500	0.06	700	2.20	36	2.23	48
LMC1608TP 3N3K	3.3@ 250MHZ	± 10,5	20	12500	0.06	700	3.40	52	3.49	81
LMC1608TP 3N6K	3.6@ 250MHZ	± 10,5	22	5900	0.06	700	3.72	53	3.71	65
LMC1608TP 3N9K	3.9@ 250MHZ	± 10,5	22	6900	0.08	700	3.95	49	3.96	67
LMC1608TP 4N3K	4.3@ 250MHZ	± 10,5	22	5900	0.06	700	4.32	50	4.33	70
LMC1608TP 4N7K	4.7@ 250MHZ	± 10,5	20	5800	0.12	700	4.72	47	4.75	57
LMC1608TP 5N1K	5.1@ 250MHZ	± 10,5	20	5700	0.14	700	4.93	47	4.95	56
LMC1608TP 5N6K	5.6@ 250MHZ	± 10,5,2	30	5700	0.08	700	5.75	41	6.04	46
LMC1608TP 6N2K	6.2@ 250MHZ	± 10,5,2	27	5800	0.10	700	6.24	57	6.51	80
LMC1608TP 6N8K	6.8@ 250MHZ	± 10,5,2	27	5800	0.11	700	6.75	60	7.10	81
LMC1608TP 7N5K	7.5@ 250MHZ	± 10,5,2	28	4800	0.11	700	7.70	60	7.82	65
LMC1608TP 8N2K	8.2@ 250MHZ	± 10,5,2	28	5600	0.11	700	8.47	63	9.24	84
LMC1608TP 8N7K	8.7@ 250MHZ	± 10,5,2	28	4600	0.11	700	8.86	62	9.32	58
LMC1608TP 9N5K	10@ 250MHZ	± 10,5,2	28	5400	0.14	700	9.70	59	9.92	61
LMC1608TP 10NK	10@ 250MHZ	± 10,5,2	31	4800	0.13	700	10.0	66	10.6	83
LMC1608TP 11NK	11@ 250MHZ	± 10,5,2	33	4000	0.09	700	11.0	53	11.5	56
LMC1608TP 12NK	12@ 250MHZ	± 10,5,2	35	4000	0.13	700	12.3	72	13.5	83
LMC1608TP 13NK	13@ 250MHZ	± 10,5,2	35	4000	0.17	700	14.1	42	16.3	54
LMC1608TP 15NK	15@ 250MHZ	± 10,5,2	35	4000	0.17	700	15.4	64	16.8	89
LMC1608TP 16NK	16@ 250MHZ	± 10,5,2	34	3300	0.10	700	16.2	55	17.3	52
LMC1608TP 18NK	18@ 250MHZ	± 10,5,2	35	3100	0.17	700	18.7	70	21.4	69
LMC1608TP 19NK	19@ 250MHZ	± 10,5,2	40	3100	0.14	700	20.3	88	23.8	96
LMC1608TP 20NK	20@ 250MHZ	± 10,5,2	40	3000	0.14	700	20.8	71	23.7	70
LMC1608TP 22NK	22@ 250MHZ	± 10,5,2	38	3000	0.19	700	22.8	73	26.1	71
LMC1608TP 23NK	23@ 250MHZ	± 10,5,2	38	2800	0.19	700	23.0	73	27.5	65
LMC1608TP 24NK	24@ 250MHZ	± 10,5,2	37	2650	0.14	700	24.5	45	28.7	39
LMC1608TP 27NK	27@ 250MHZ	± 10,5,2	40	2800	0.22	600	29.2	74	34.6	65
LMC1608TP 30NK	30@ 250MHZ	± 10,5,2	37	2250	0.14	600	31.4	47	39.9	28
LMC1608TP 33NK	33@ 250MHZ	± 10,5,2	40	2300	0.22	600	36.0	67	49.5	42
LMC1608TP 36NK	36@ 250MHZ	± 10,5,2	38	2080	0.25	600	39.4	47	52.7	24
LMC1608TP 39NK	39@ 250MHZ	± 10,5,2	40	2200	0.25	600	42.7	60	60.2	40
LMC1608TP 43NK	43@ 250MHZ	± 10,5,2	39	2000	0.28	600	47.0	44	64.9	21
LMC1608TP 47NK	47@ 200MHZ	± 10,5,2	38	2000	0.28	600	52.2	62	77.2	35
LMC1608TP 51NK	51@ 200MHZ	± 10,5,2	36	2000	0.30	600	60.0	62	82.2	34
LMC1608TP 56NK	56@ 200MHZ	± 10,5,2	38	1900	0.31	600	62.5	56	97.0	26
LMC1608TP 60NK	60@ 200MHZ	± 10,5,2	38	1800	0.33	600	75.9	70	202	25
LMC1608TP 62NK	62@ 200MHZ	± 10,5,2	38	1800	0.33	600	75.0	58	120	32
LMC1608TP 68NK	68@ 200MHZ	± 10,5,2	37	1700	0.34	600	80.5	54	168	21
LMC1608TP 72NK	72@ 150MHZ	± 10,5,2	34	1700	0.49	400	82.0	53	135	20
LMC1608TP 75NK	75@ 150MHZ	± 10,5,2	34	1700	0.50	400	90.0	54	160	25
LMC1608TP 82NK	82@ 150MHZ	± 10,5,2	34	1700	0.54	400	96.2	54	177	21
LMC1608TP 91NK	91@ 150MHZ	± 10,5,2	34	1500	0.56	400	110	44	200	18
LMC1608TP R10K	100@ 150MHZ	± 10,5,2	34	1400	0.58	400	124	49	-	-
LMC1608TP R11K	110@ 150MHZ	± 10,5,2	32	1350	0.61	300	138	43	-	-
LMC1608TP R12K	120@ 150MHZ	± 10,5,2	32	1300	0.75	300	166	39	-	-
LMC1608TP R15K	150@ 150MHZ	± 10,5,2	28	990	0.92	280	250	25	-	-
LMC1608TP R16K	160@ 150MHZ	± 10,5,2	28	990	1.10	260	324	31	-	-

# LMC1608

Ordering code <sup>1</sup>	Inductance <sup>2</sup> [nH]	Tolerance <sup>3</sup> (%)	Q <sup>4</sup> (min.)	SRF Min. <sup>5</sup> (MHz)	Rdc Max. <sup>6</sup> (Ω)	Idc Max. <sup>7</sup> (mA)	900MHz		1.7GHz	
							L Typ	Q typ	L Typ	Q typ
LMC1608TP R18K	180@ 100MHZ	± 10,5,2	25	990	1.25	240	305	22	-	-
LMC1608TP R19K	190@ 100MHZ	± 10,5,2	28	950	1.50	220	427	30	-	-
LMC1608TP R20K	200@ 100MHZ	± 10,5,2	25	950	1.30	220	465	30	-	-
LMC1608TP R22K	220@ 100MHZ	± 10,5,2	25	900	1.90	200	480	8	-	-
LMC1608TP R23K	230@ 100MHZ	± 10,5,2	24	900	2.00	180	677	24	-	-
LMC1608TP R24K	240@ 100MHZ	± 10,5,2	24	900	2.00	180	770	21	-	-
LMC1608TP R25K	250@ 100MHZ	± 10,5,2	24	900	2.00	180	680	6	-	-
LMC1608TP R27K	270@ 100MHZ	± 10,5,2	24	900	2.90	170	980	4	-	-
LMC1608TP R29K	290@ 100MHZ	± 10,5,2	24	850	3.10	170	1080	3	-	-
LMC1608TP R30K	300@ 100MHZ	± 10,5,2	24	850	2.70	170	1080	2	-	-
LMC1608TP R33K	330@ 100MHZ	± 10,5,2	24	800	4.00	150	1380	2	-	-
LMC1608TP R39K	390@ 100MHZ	± 10,5,2	24	800	4.30	150	1580	2	-	-
LMC1608TP R40K	400@ 100MHZ	± 10,5,2	24	800	4.30	150	-	-	-	-

1. How to order

**LM C 1608 TP 1N6 K**  
 (1) (2) (3) (4) (5) (6)

- (1) Part name
- (2) Material
- (3) Body size
- (4) TP: Taping
- (5) Inductance Value  
Ex: 3N3(3.3nH), 560(56nH), 391(390nH)
- (6) Inductance Tol.

2. Inductance measured: RF LCR METER(HP4286A)+16193A fixture

3. G=±2%, J=±5%, K=±10%

4. Q measured: RF LCR METER(HP4286A)+16193A fixture

5. SRF measured: network analyzer(HP8753D)+ABCO SMD-D test fixture

6. Rdc measured: RF LCR METER(HP4286A)+16193A fixture

7. Idc measured: For 15°C Rise

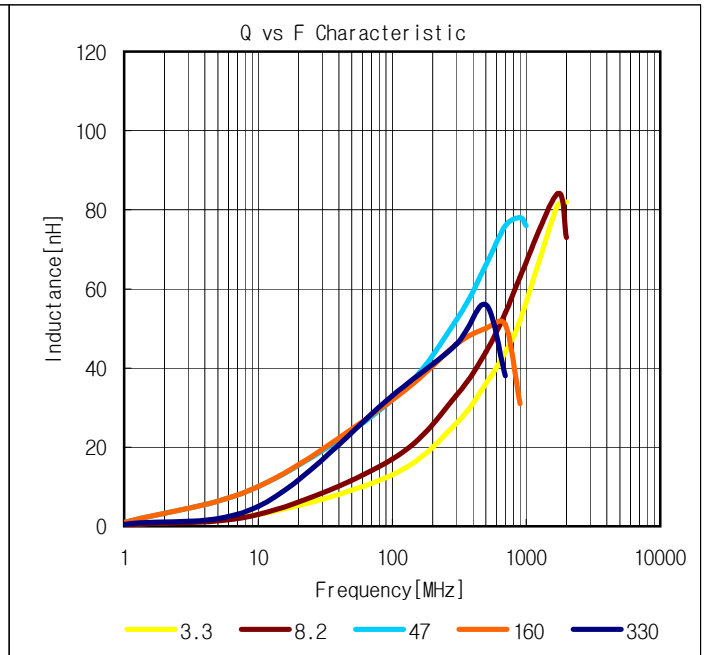
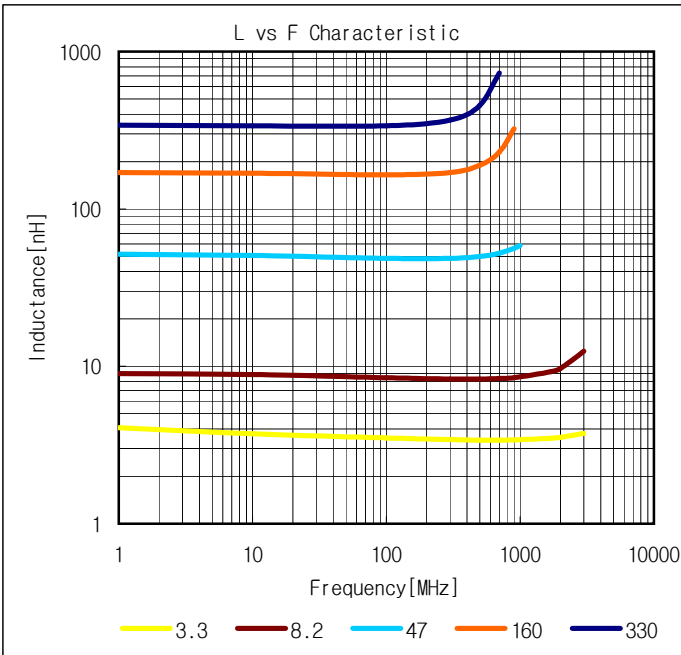

# ITEM PART NUMBERS

LMC1005										
Ordering code <sup>1</sup>	Inductance <sup>2</sup> [nH]	Tolerance <sup>3</sup> (%)	Q <sup>4</sup> (min.)	SRF Min. <sup>5</sup> (MHZ)	Rdc Max. <sup>6</sup> ( $\Omega$ )	Idc Max. <sup>7</sup> (mA)	900MHz		1.7GHz	
							L Typ	Q typ	L Typ	Q typ
LMC1005TP 1N0K	1.0@ 250MHZ	± 10,5	9	6000	0.080	1360	1.02	77	1.02	69
LMC1005TP 1N5K	1.5@ 250MHZ	± 10,5	13	6000	0.040	1260	1.50	31	1.52	51
LMC1005TP 1N7K	1.7@ 250MHZ	± 10,5	15	6000	0.050	1060	1.72	45	1.78	66
LMC1005TP 1N8K	1.8@ 250MHZ	± 10,5	15	6000	0.050	1060	1.74	46	1.76	64
LMC1005TP 2N0K	2.0@ 250MHZ	± 10,5	16	6000	0.070	1040	1.93	54	1.93	75
LMC1005TP 2N2K	2.2@ 250MHZ	± 10,5	19	6000	0.070	960	2.19	59	2.23	85
LMC1005TP 2N3K	2.3@ 250MHZ	± 10,5	10	6000	0.090	800	2.28	37	2.32	45
LMC1005TP 2N7K	2.7@ 250MHZ	± 10,5	19	6000	0.022	520	2.68	38	2.75	56
LMC1005TP 3N3K	3.3@ 250MHZ	± 10,5	19	6000	0.066	840	3.10	65	3.12	87
LMC1005TP 3N6K	3.6@ 250MHZ	± 10,5	19	6000	0.066	840	3.56	45	3.62	71
LMC1005TP 3N9K	3.9@ 250MHZ	± 10,5	19	5800	0.066	840	3.79	52	3.95	72
LMC1005TP 4N7K	4.7@ 250MHZ	± 10,5	20	5800	0.070	800	4.62	41	4.81	60
LMC1005TP 5N1K	5.1@ 250MHZ	± 10,5	20	5800	0.083	800	5.15	56	5.3	82
LMC1005TP 5N6K	5.6@ 250MHZ	± 10,5	20	5800	0.083	760	5.16	54	5.3	81
LMC1005TP 6N2K	6.2@ 250MHZ	± 10,5	20	5800	0.083	760	6.16	52	6.4	76
LMC1005TP 6N6K	6.6@ 250MHZ	± 10,5	22	5800	0.100	760	6.50	52	6.9	74
LMC1005TP 6N8K	6.8@ 250MHZ	± 10,5	22	5800	0.100	760	6.80	53	7.3	74
LMC1005TP 7N5K	7.5@ 250MHZ	± 10,5	22	5800	0.104	680	7.91	60	8.2	88
LMC1005TP 8N2K	8.2@ 250MHZ	± 10,5	22	4400	0.104	680	8.30	56	9.0	69
LMC1005TP 9N0K	9.0@ 250MHZ	± 10,5	22	4160	0.130	680	9.07	62	9.5	78
LMC1005TP 10NK	10@ 250MHZ	± 10,5	21	3900	0.195	480	9.80	50	10.1	67
LMC1005TP 11NK	11@ 250MHZ	± 10,5	24	3680	0.120	640	10.7	52	11.2	78
LMC1005TP 12NK	12@ 250MHZ	± 10,5	24	3600	0.160	640	12.4	54	14.0	63
LMC1005TP 13NK	13@ 250MHZ	± 10,5	25	3600	0.120	630	13.3	58	14.8	78
LMC1005TP 14NK	14@ 250MHZ	± 10,5	24	3350	0.160	590	14.6	54	15.7	76
LMC1005TP 15NK	15@ 250MHZ	± 10,5	24	3280	0.172	560	14.6	55	15.5	77
LMC1005TP 16NK	16@ 250MHZ	± 10,5	24	3200	0.210	530	16.2	54	19.1	59
LMC1005TP 18NK	18@ 250MHZ	± 10,5	24	3100	0.190	520	18.6	45	22.2	50
LMC1005TP 19NK	19@ 250MHZ	± 10,5	24	3040	0.260	480	20.3	54	24.8	55
LMC1005TP 20NK	20@ 250MHZ	± 10,5	24	2950	0.270	450	20.6	52	24.2	56
LMC1005TP 22NK	22@ 250MHZ	± 10,5	24	2840	0.300	390	23.8	49	26.9	64
LMC1005TP 23NK	23@ 250MHZ	± 10,5	24	2720	0.280	400	23.8	49	26.9	64
LMC1005TP 24NK	24@ 250MHZ	± 10,5	24	2580	0.350	380	26.3	50	32.8	50
LMC1005TP 25NK	25@ 250MHZ	± 10,5	24	2550	0.350	380	25.8	58	33.1	52
LMC1005TP 27NK	27@ 250MHZ	± 10,5	24	2480	0.330	400	27.7	50	36.1	48
LMC1005TP 30NK	30@ 250MHZ	± 10,5	24	2400	0.400	350	31.2	49	42.0	58
LMC1005TP 33NK	33@ 250MHZ	± 10,5	25	2400	0.480	300	21.5	46	39.5	60
LMC1005TP 36NK	36@ 250MHZ	± 10,5	24	2320	0.480	320	39.5	44	48.4	53
LMC1005TP 39NK	39@ 250MHZ	± 10,5	24	2260	0.490	320	41.0	46	49.5	40
LMC1005TP 40NK	40@ 250MHZ	± 10,5	24	2240	0.550	320	39.0	44	47.4	33
LMC1005TP 47NK	47@ 250MHZ	± 10,5	20	2210	0.830	150	50.0	38	85.0	56
LMC1005TP 51NK	51@ 250MHZ	± 10,5	23	2180	0.850	120	60.5	44	95.4	49
LMC1005TP 56NK	56@ 250MHZ	± 10,5	22	2160	1.250	100	66.2	46	148.5	25
LMC1005TP 68NK	68@ 250MHZ	± 10,5	22	2020	1.520	92	78.8	40	171.5	48
LMC1005TP 82NK	82@ 250MHZ	± 10,5	20	1940	1.630	84	105.5	41	820.8	5



1.How to order

**LM C 1005 TP 1N0 K**  
 (1) (2) (3) (4) (5) (6)

- (1)Part name
- (2)Material
- (3)Body size
- (4)TP:Taping
- (5)Inductance Value  
 Ex:3N3(3.3nH),560(56nH),391(390nH)
- (6)Inductance Tol.

2.Inductance measured:RF LCR METER(HP4287A)+16193A fixture

3.G=±2%,J=±5%,K=±10%

4.Q measured:RF LCR METER(HP4287A)+16193A fixture

5.SRF measured:network analyzer(HP8753D)+ABCO SMD-D test fixture

6.Rdc measured:RF LCR METER(HP4287A)+16193A fixture

7.Idc measured:For 15°C Rise

