

# LQW18AN8N2D00#

“#” indicates a package specification code.

Size Code 1608 (0603) in mm (in inch), Wound Type



< List of part numbers with package codes >

LQW18AN8N2D00B      LQW18AN8N2D00D      LQW18AN8N2D00J

## Appearance & Shape

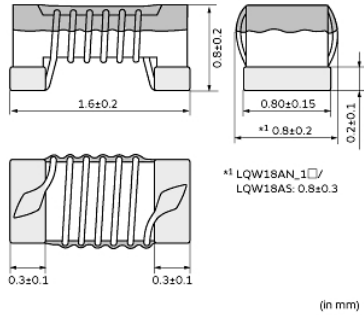

## References

Packaging	Specifications	Standard Packing Quantity
B	Bulk(Bag)	500
D	180mm Paper Tape	4000
J	330mm Paper Tape	10000

Mass (typ.)	
1 piece	0.003g

### Attention

- 1.This datasheet is downloaded from the website of Murata Manufacturing Co., Ltd. Therefore, it's specifications are subject to change or our products in it may be discontinued without advance notice. Please check with our sales representatives or product engineers before ordering.
- 2.This datasheet has only typical specifications because there is no space for detailed specifications. Therefore, please review our product specifications or consult the approval sheet for product specifications before ordering.

# LQW18AN8N2D00#

“#” indicates a package specification code.



## Specifications

L size	1.6±0.2mm
W size	0.8±0.2mm
T size	0.8±0.2mm
Size code inch (mm)	0603 (1608)
Inductance	8.2nH±0.5nH
Inductance Test Frequency	100MHz
Rated current (Itemp) (Based on Temperature rise)	650mA
Max. of DC resistance	0.11Ω
Q(min.)	35
Q Test Frequency	250MHz
Self resonance frequency (min.)	6000MHz
Operating Temperature Range(Self-temperature rise is not included)	-55°C to 125°C
Series	LQW18AN_00

### Attention

1.This datasheet is downloaded from the website of Murata Manufacturing Co., Ltd. Therefore, it's specifications are subject to change or our products in it may be discontinued without advance notice. Please check with our sales representatives or product engineers before ordering.

2.This datasheet has only typical specifications because there is no space for detailed specifications.

Therefore, please review our product specifications or consult the approval sheet for product specifications before ordering.

# LQW18AN8N2D00#

“#” indicates a package specification code.

## Characteristic Data

The charts below may show another part number which shares its characteristics.

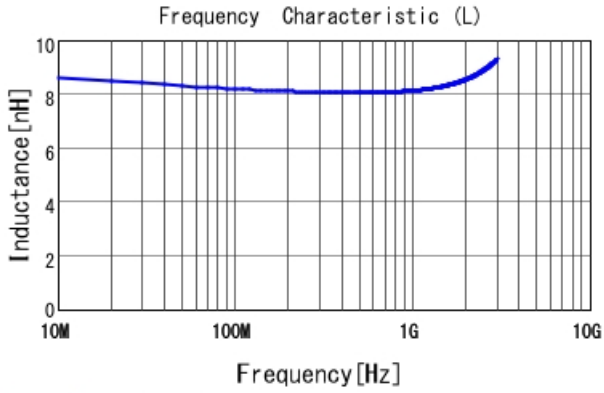

LQW18AN8N2D00 L

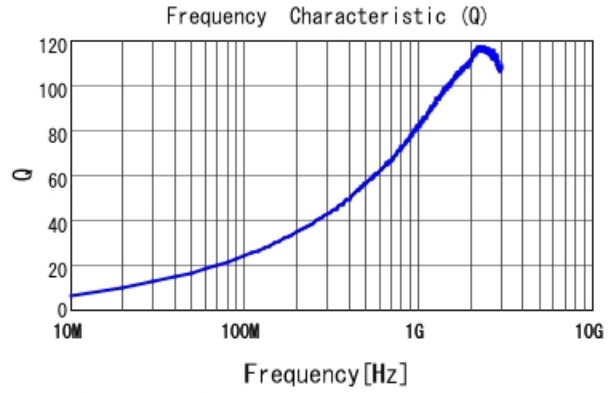

LQW18AN8N2D00 Q

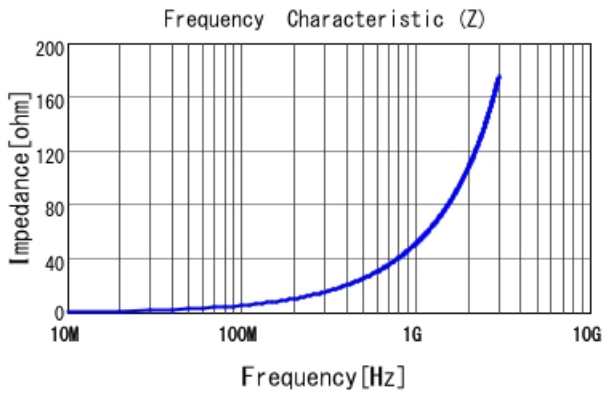

LQW18AN8N2D00 |Z|

**Attention**

- 1.This datasheet is downloaded from the website of Murata Manufacturing Co., Ltd. Therefore, it's specifications are subject to change or our products in it may be discontinued without advance notice. Please check with our sales representatives or product engineers before ordering.
- 2.This datasheet has only typical specifications because there is no space for detailed specifications. Therefore, please review our product specifications or consult the approval sheet for product specifications before ordering.