



# TAI-SAW TECHNOLOGY CO., LTD.

No. 3, Industrial 2nd Rd., Ping-Chen Industrial District,  
Taoyuan, 324, Taiwan, R.O.C.

TEL: 886-3-4690038 FAX: 886-3-4697532

E-mail: [tstsales@mail.taisaw.com](mailto:tstsales@mail.taisaw.com) Web: [www.taisaw.com](http://www.taisaw.com)

## Approval Sheet For Product Specification

Issued Date: Jun, 26, 2007

Product Name: SAW Filter 1765 MHz SMD 3.0X3.0 mm

TST Parts No.: TA0702A

Customer Parts No.: \_\_\_\_\_

Company: _____
Division: _____
Approved by : _____
Date: _____

Checked by: \_\_\_\_\_ Bob Chau

Approval by: \_\_\_\_\_ Francis Chen

Date: \_\_\_\_\_ 6, 26, 2007



# TAI-SAW TECHNOLOGY CO., LTD.

No. 3, Industrial 2nd Rd., Ping-Chen Industrial District,  
Taoyuan, 324, Taiwan, R.O.C.

TEL: 886-3-4690038 FAX: 886-3-4697532

E-mail: [tstsales@mail.taisaw.com](mailto:tstsales@mail.taisaw.com) Web: [www.taisaw.com](http://www.taisaw.com)

## SAW Filter 1765 MHz

MODEL NO.:TA0702A

REV. NO.:1

### A. MAXIMUM RATING:

1. Input Power Level: 10 dBm
2. DC Voltage : 3V
3. Operating Temperature: -20°C to +75°C
4. Storage Temperature: -40°C to +85°C

RoHS Compliant  
Lead free  
Lead-free soldering

### B. ELECTRICAL CHARACTERISTICS:

Item	Unit	Min.	Type.	Max.	Note
Center Frequency <b>Fc</b>	MHz	-	1765	-	-
Insertion Loss (1750 ~ 1780 MHz) <b>IL</b>	dB	-	2	3	-
Amplitude Ripple (1750 ~ 1780 MHz)	dB	-	0.5	1.8	-
VSWR (1750 ~ 1780 MHz)		-	1.45	2	-
<b>Attenuation</b> (Reference level from 0 dB)					
1350 ~ 1380 MHz	dB	30	35.5	-	-
1660 ~ 1690 MHz	dB	28	37.5	-	-
1840 ~ 1870 MHz	dB	30	46	-	-
2150 ~ 2180 MHz	dB	30	42	-	-

### C. MEASUREMENT CIRCUIT:

HP Network analyzer

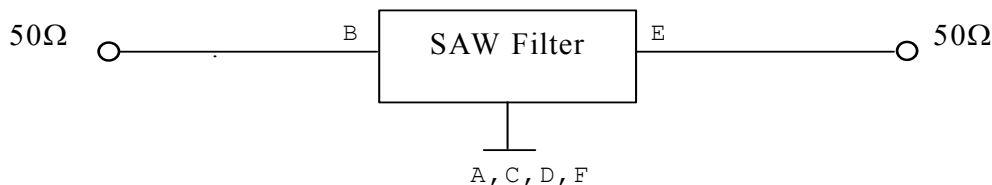

**D.OUTLINE DRAWING:**

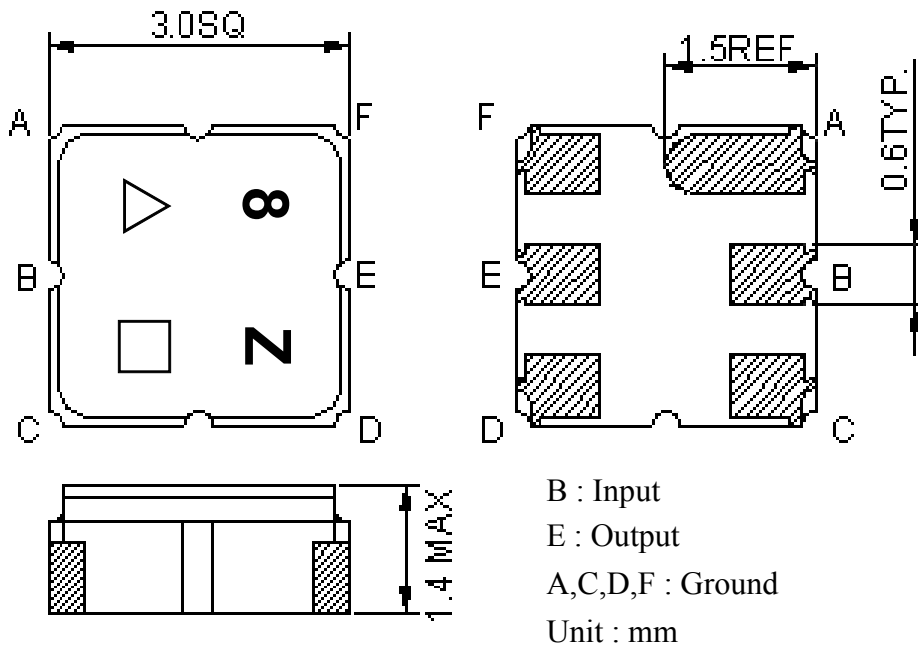

△ : Year Code (2006->6, ..., 2009->9)

□ : Date Code (Follow the table from planner each year)

**E. PCB Footprint:**

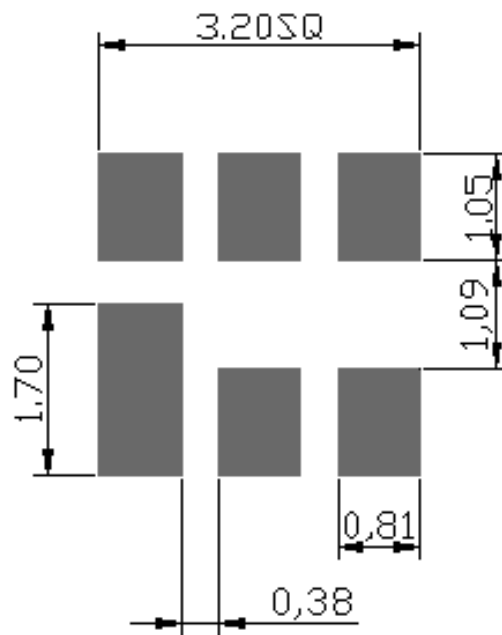

## F. Frequency Characteristics :

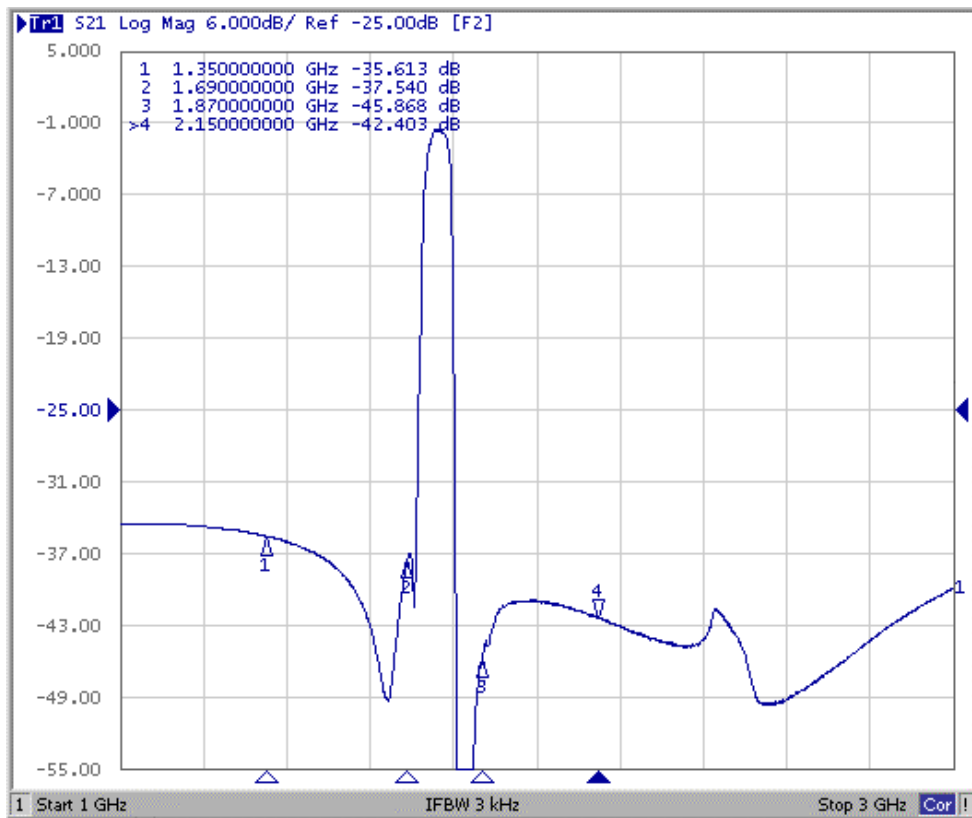
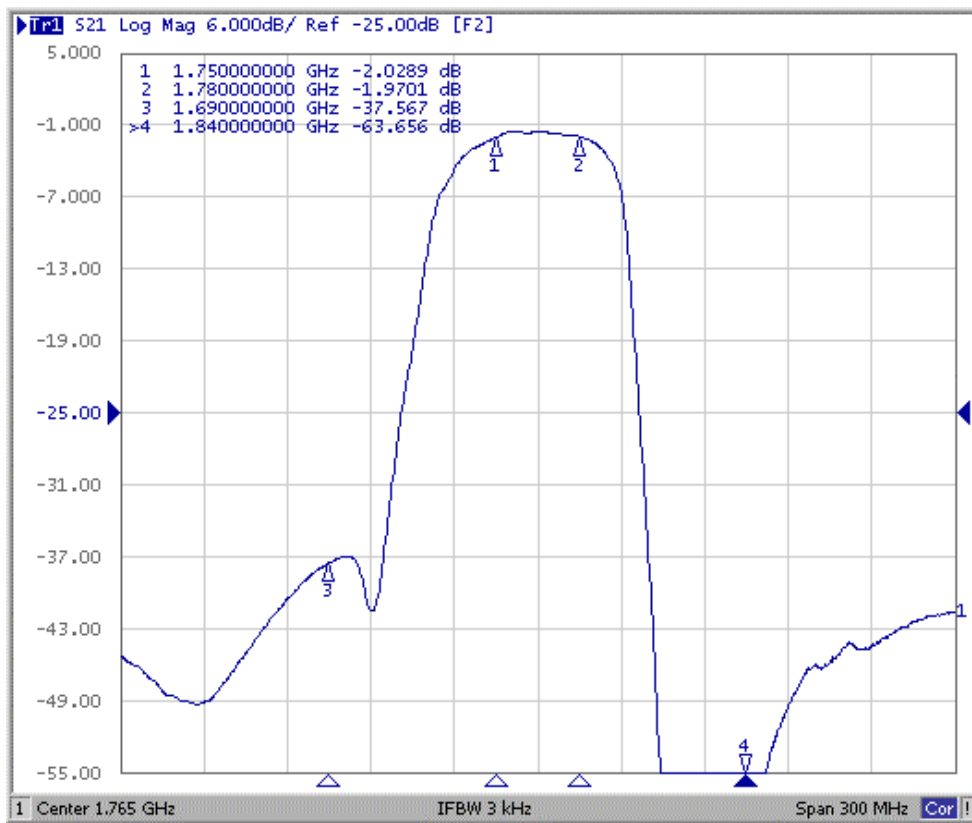

# Reflection Functions :

## S11

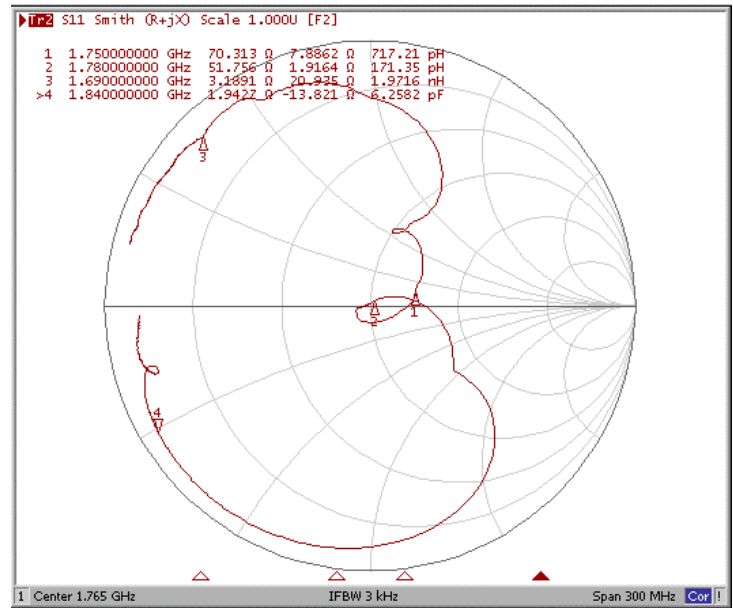
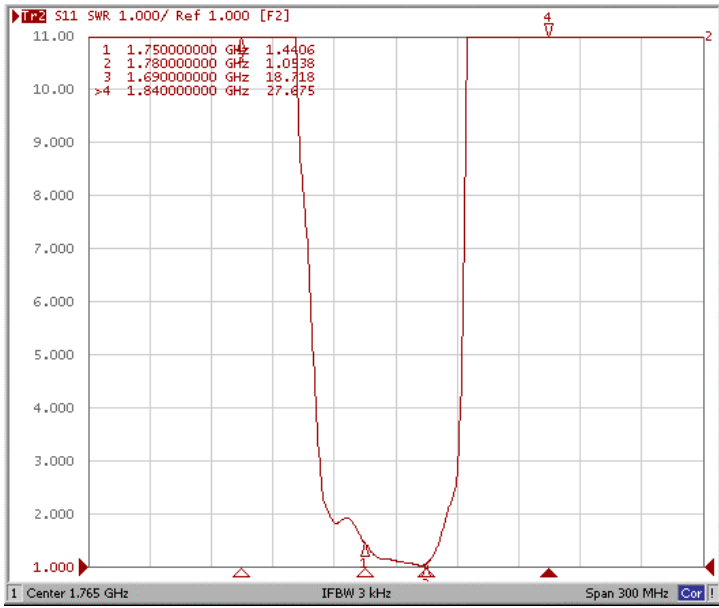

## S22

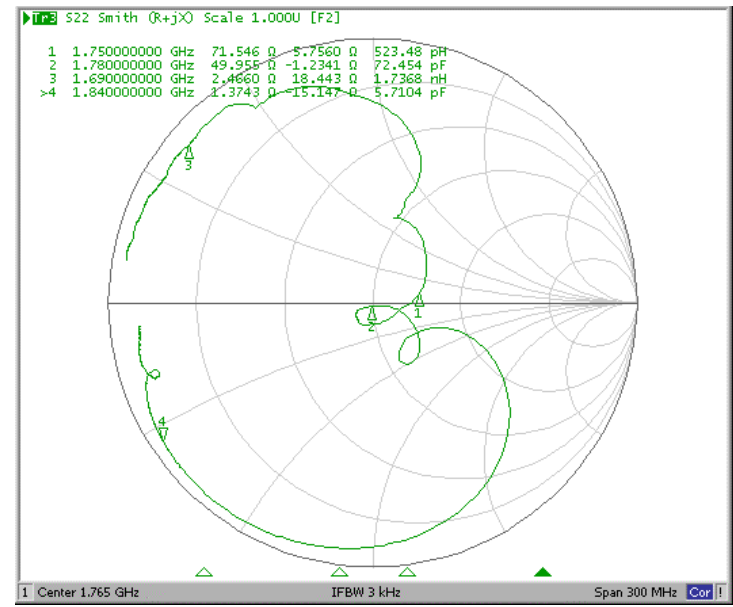
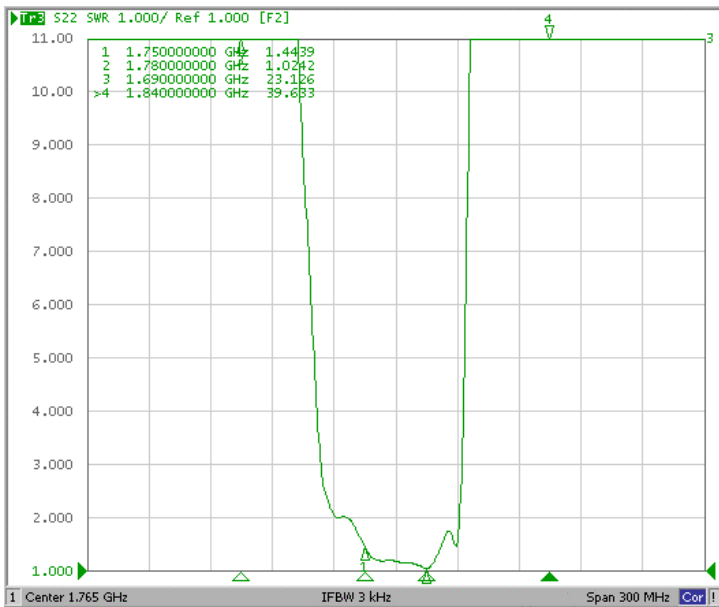

**G. PACKING:**

**1. REEL DIMENSION**

(Reel Count : 7''=1000 ; 13''=3000 )



**2.TAPE DIMENSION**

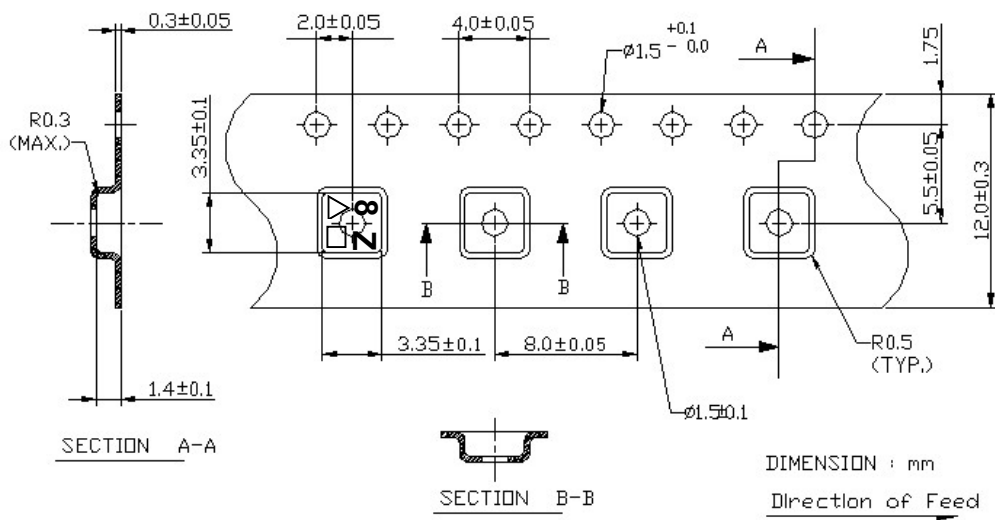

## H. RECOMMENDED REFLOW PROFILE :

