

<b>Datasheet</b>	<b>Created Date</b>	<b>Document No.</b>	<b>Document Retention</b>	<b>Security</b>		<b>Author</b>
	2017-05-17		<b>Permanent</b>	<input checked="" type="checkbox"/> Non-Confidential/ <input type="checkbox"/> Confidential		G.H.Baek
<b>Department</b>	Research Institute		<b>Reference</b>		<b>Receiver</b>	



## Datasheet

# V3737NB

Rev. 1.0

***Release Date 2017-05-17***

Copyright © 2016 RN2 Technologies Co., Ltd. All Rights Reserved.

## Revision History

Rev	Release Date	Description	Author
1.0	2017-05-17	• Initial release	G.H. Baek



# 250W, Termination with High-Power Capacity and Stable Performance based on RN2 Resistor Technology

**Model Name: *V3737NB***

## KEY FEATURES

- Excellent high-power capacity up to average 250watts
- Excellent stable performance at different temperatures
- Surface mount type
- RoHS compliance (Pb-Free)

## APPLICATIONS

- Applications using mobile networks, broadcast
- High power amplifiers
- Isolator, Circulator
- Military

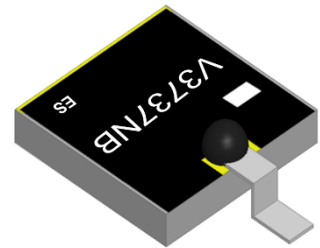

## GENERAL DESCRIPTIONS

The V3737NB is a 250W termination with high-power capacity and stable performance in different temperatures. The AIN, high conductivity metal conductor (Ag), and gold (Au) plating enable the V3737NB to low VSWR and improve durability for thermal stabilization and electricity.

The V3737NB is suited for applications using GSM, UMTS, and LTE and communications equipment, requiring high power.

The V3737NB supports up to average 250 watts. It is a SMD type product enabling Pb-Free solder and meets RoHS-6.

## ELECTRICAL SPECIFICATIONS

Frequency (MHz)	DC Impedance (ohms)	Return Loss(S11) (dB, Min.)	Power Capacity Avg.(Watt)	Operating Temperature( °C)
DC - 2300	50 ± 2%	20	250	-55 - +125

**NOTE:** These electrical specifications are measured by using a RN2 test board.  
Specifications subject to change without notice.

## Contents

<b>KEY FEATURES</b> .....	<b>3</b>
<b>APPLICATIONS</b> .....	<b>3</b>
<b>GENERAL DESCRIPTIONS</b> .....	<b>3</b>
<b>ELECTRICAL SPECIFICATIONS</b> .....	<b>3</b>
<b>PORT CONFIGURATIONS</b> .....	<b>5</b>
<b>MECHANICAL SPECIFICATIONS</b> .....	<b>5</b>
<b>POWER DERATING CURVE</b> .....	<b>6</b>
<b>RF PERFORMANCE CURVES</b> .....	<b>7</b>
<b>RF TEST METHODS</b> .....	<b>8</b>
RF TEST PROCEDURES .....	8
RN2 TEST BOARD LAYOUT .....	10
<b>RECOMMENDED PCB LAYOUT AND SOLDER MASK PATTERN</b> .....	<b>11</b>
<b>SOLDERING PROCESS</b> .....	<b>12</b>
<b>REFLOW PROFILE</b> .....	<b>13</b>
<b>PACKAGING AND ORDERING INFORMATION</b> .....	<b>14</b>
<b>CAUTION</b> .....	<b>15</b>
<b>LEGAL INFORMATION</b> .....	<b>16</b>

## PORT CONFIGURATIONS

**Figure 1** shows the locations of the V3737NB ports. The orientation marker is included to represent input port.

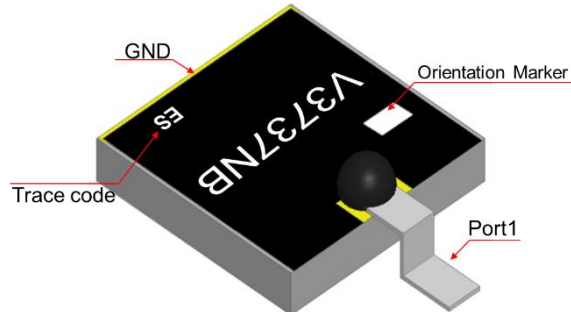

**Figure 1. V3737NB (Top View)**

## MECHANICAL SPECIFICATIONS

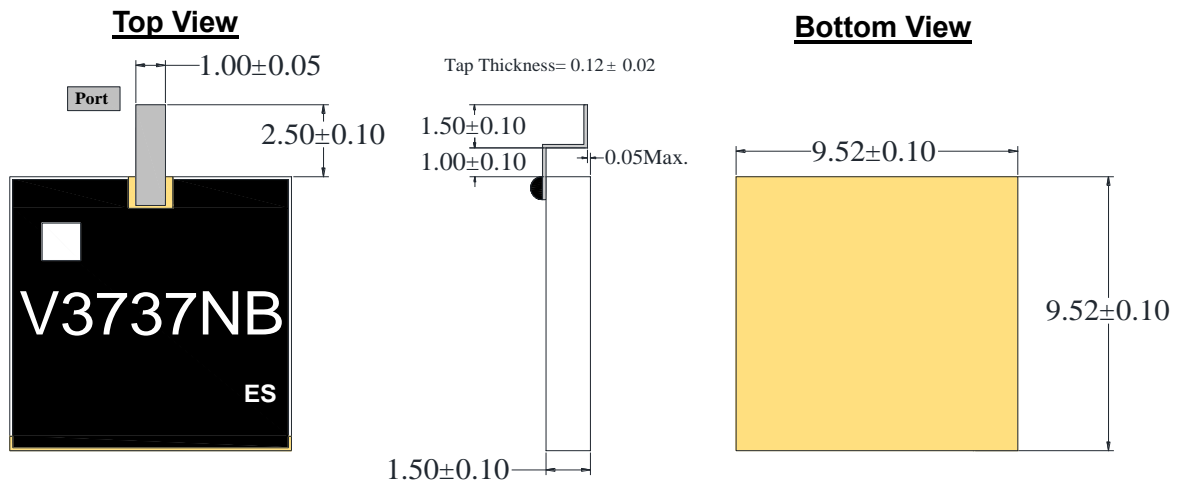

- Weight: 0.49 grams
- Camber specifications: Less than  $\pm 0.08$  mm

## POWER DERATING CURVE

**Figure 2** shows the maximum allowable average power (Maximum input power, CW) of the V3737NB depending on base PCB temperature changes. The maximum allowable average power of the V3737NB is limited by the following power derating curve.

The V3737NB factors that determine the power derating curve are as follows:

- Internal circuit
- Thickness
- Thermal conductivity of materials
- Operating temperature
- Mounting interface temperature between the V3737NB and the base PCB

The maximum operating temperature of the V3737NB is 125 °C. Therefore, when the base PCB temperature is over 125 °C, the V3737NB operates stably by decreasing its durable average input power. When the base PCB temperature reaches 200 °C, the maximum allowable average power decreases to 0 watt.

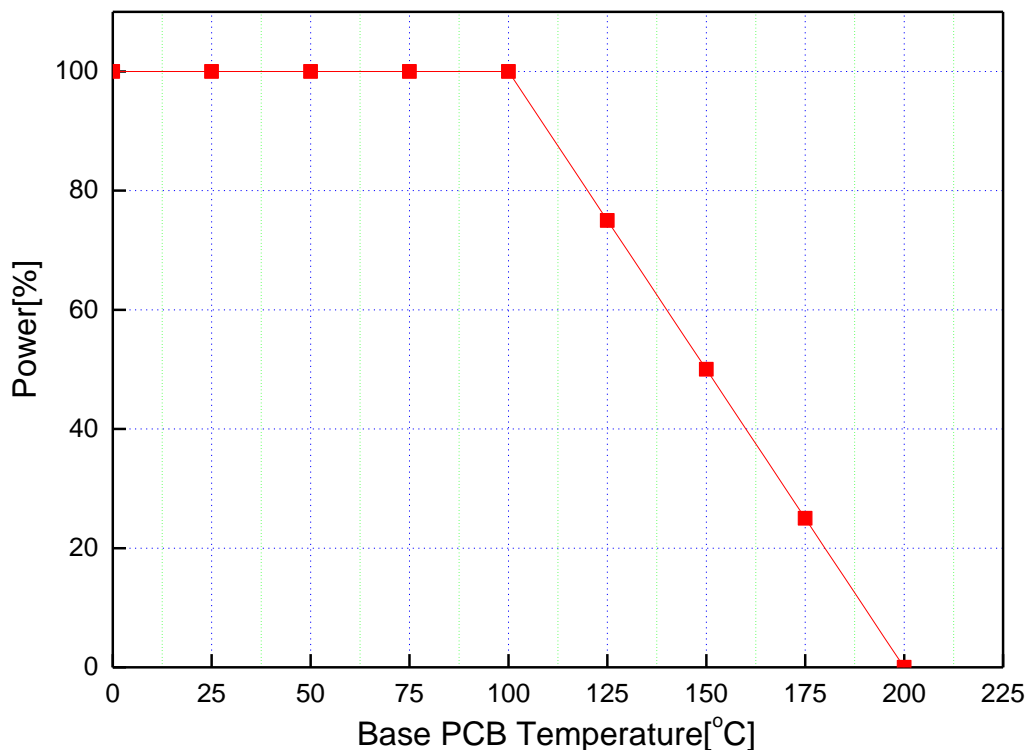

**Figure 2. Power Derating Curve**

## RF PERFORMANCE CURVES

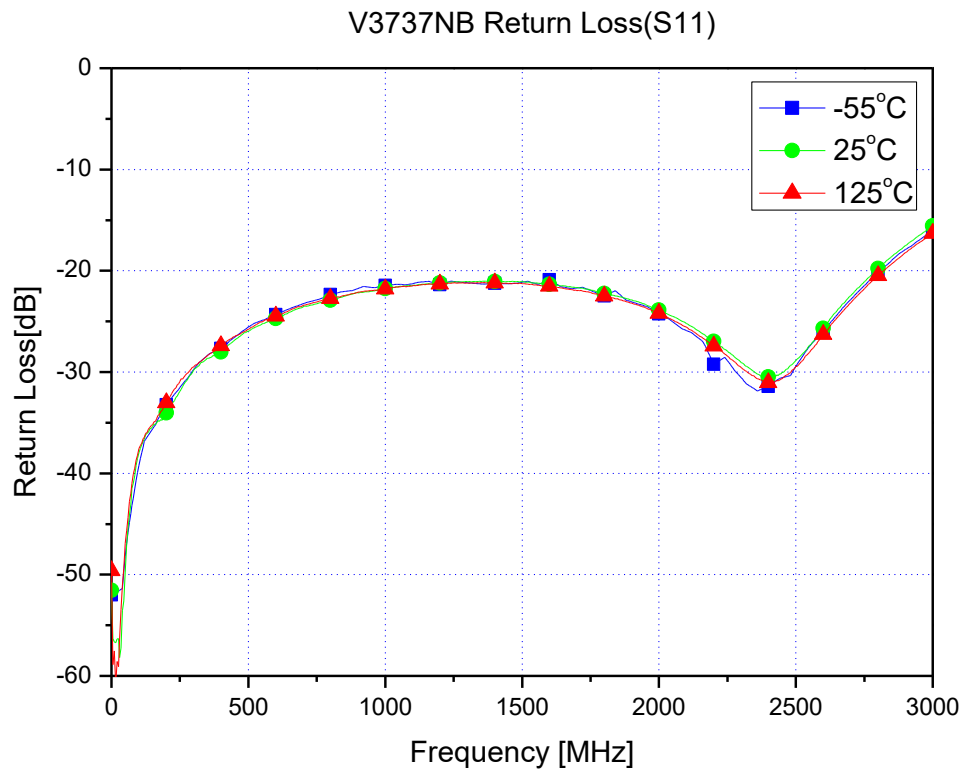

## RF TEST METHODS

This section describes how to test the V3737NB RF performance. To ensure s-parameters reliability, we follow our internal test procedures by using the RN2 bare test board, RN2 test board, Vector network analyzer, and test fixture. In addition, we use the Automatic Port Extensions (APE) function of the Vector network analyzer to obtain accurate s-parameters.

Check the following sections for more details:

- RF TEST PROCEDURES
- RN2 TEST BOARD LAYOUT
- AUTOMATIC PORT EXTENSIONS (APE) FUNCTION

## RF TEST PROCEDURES

To test the V3737NB RF performance, we perform the following steps:

1. Preparing the Test Equipment
2. Performing the Automatic Port Extensions (APE) Function of the Vector Network Analyzer
3. Measuring the S-parameters (Impedance and Return Loss)
4. Obtaining the Characteristic Parameters (Impedance and Return Loss)

### STEP 1: Preparing the Test Equipment

The following test equipment is prepared to test the V3737NB RF performance.

- RN2 bare test board
- RN2 test board
- Vector network analyzer
- Test fixture

**NOTE:** See [‘RN2 TEST BOARD LAYOUT’](#) for the RN2 test board details.

### STEP 2: Performing the Automatic Port Extensions (APE) Function of the Vector Network Analyzer

The APE function is used with the RN2 bare test board to correctly check the V3737NB RF performance. This reduces or eliminates both electrical delay and insertion loss of the test fixture.

The detailed steps are as follows:

1. Place the RN2 bare test board on the test fixture.
2. Click the **Cal** button of the Vector network analyzer to calibrate it.
3. Connect the four ports of the test fixture into the four ports of the Vector network analyzer.
4. Click the **Port Extensions** button of the Vector network analyzer to measure the data of the RN2 bare test board.

**NOTE:** See [‘AUTOMATIC PORT EXTENSIONS FUNCTION’](#) for more details.



**STEP 3: Measuring the S-parameters (Impedance and Return Loss)**

After performing the APE function, the V3737NB s-parameters are measured through the following steps:

1. Place the RN2 test board on the text fixture.
2. Apply pressure to the text fixture using a pneumatic piston.
3. Connect the four ports of the test fixture into the four ports of the Vector network analyzer.
4. Calibrate the Vector network analyzer.
5. Measure the Impedance and return loss value from port 1 to port 1 (S11).

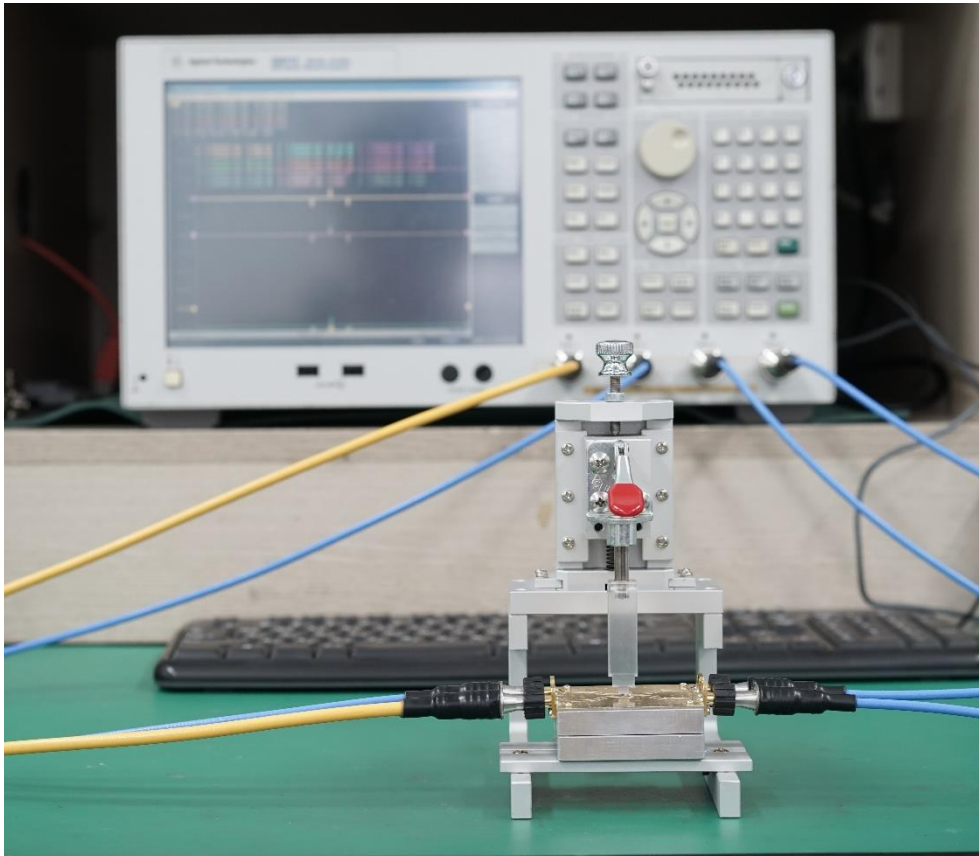

**Figure 3. Test Setting to Measure the V3737NB S-parameters**

## RN2 TEST BOARD LAYOUT

**Figure 6** shows the RN2 test board layout used for testing the V3737NB RF performance. The RN2 test board is based on the Taconic RF35 board with the dielectric constant of 3.5, board thickness of 0.8 mm, and copper of 1 Oz.

We recommend that you use the same material and design layout, as shown in **Figure 6**, to meet the specifications in this datasheet. However, if you use different materials, you must follow the basic guidelines. See [‘RECOMMENDED PCB LAYOUT AND SOLDER MASK PATTERN’](#) for more details.

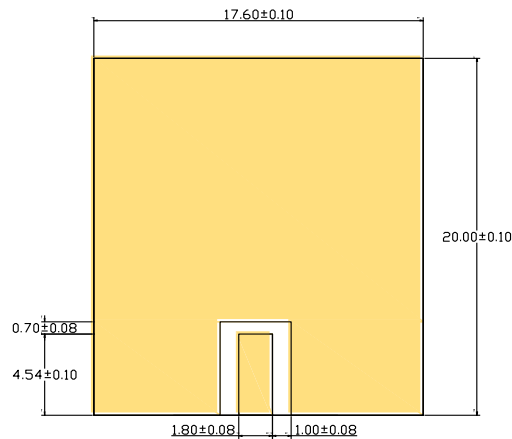

Figure 4. RN2 Test Board Layout

## AUTOMATIC PORT EXTENSIONS (APE) FUNCTION

To accurately measure the V3737NB s-parameters, we use the Automatic Port Extensions (APE) function of the Vector network analyzer. The APE function is used for reducing or eliminating both electrical delay and insertion loss of test fixtures. It provides a convenient, automated way to calculate the insertion loss and electrical delay terms by a simple measurement of an open or short circuit, which is easy to do in test fixtures.

We consider the transmission lines of the RN2 bare test board as extensions of the coaxial test cables that are between the Vector network analyzer and the V3737NB. With the APE function, we extend the coaxial test ports so that our calibration plane is right at the terminals of the V3737NB, and not at the connectors of the RN2 bare test board.

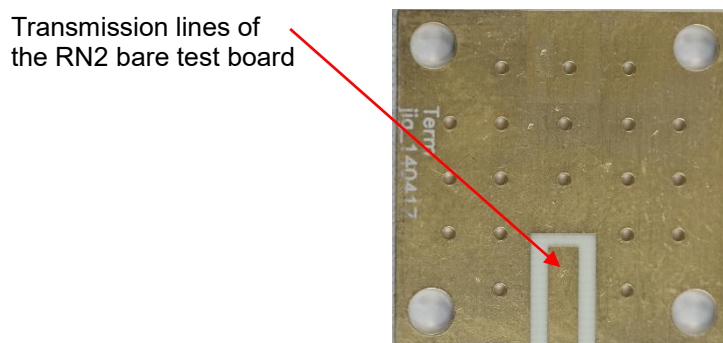

Figure 5. Performing the APE Function Test

## RECOMMENDED PCB LAYOUT AND SOLDER MASK PATTERN

**Figure 6** shows the recommended PCB layout and solder mask pattern to meet the specifications in this datasheet. When you use different materials other than the RN2 test board, you must follow the basic guidelines at minimum.

### Basic Guidelines

- Place GND more than 30% of the V3737NB GND dimension regardless of a via size.
- Appropriately increase via sizes and numbers to allow low impedance ground connection and good thermal conductivity.
- Align the V3737NB ground plane with the solder to have good connection to ground.
- Fill the via holes under the V3737NB with the solder for thermal emission.

**NOTE:** Contact the RN2 Technologies sales team for more detailed PCB layout and solder mask pattern information.

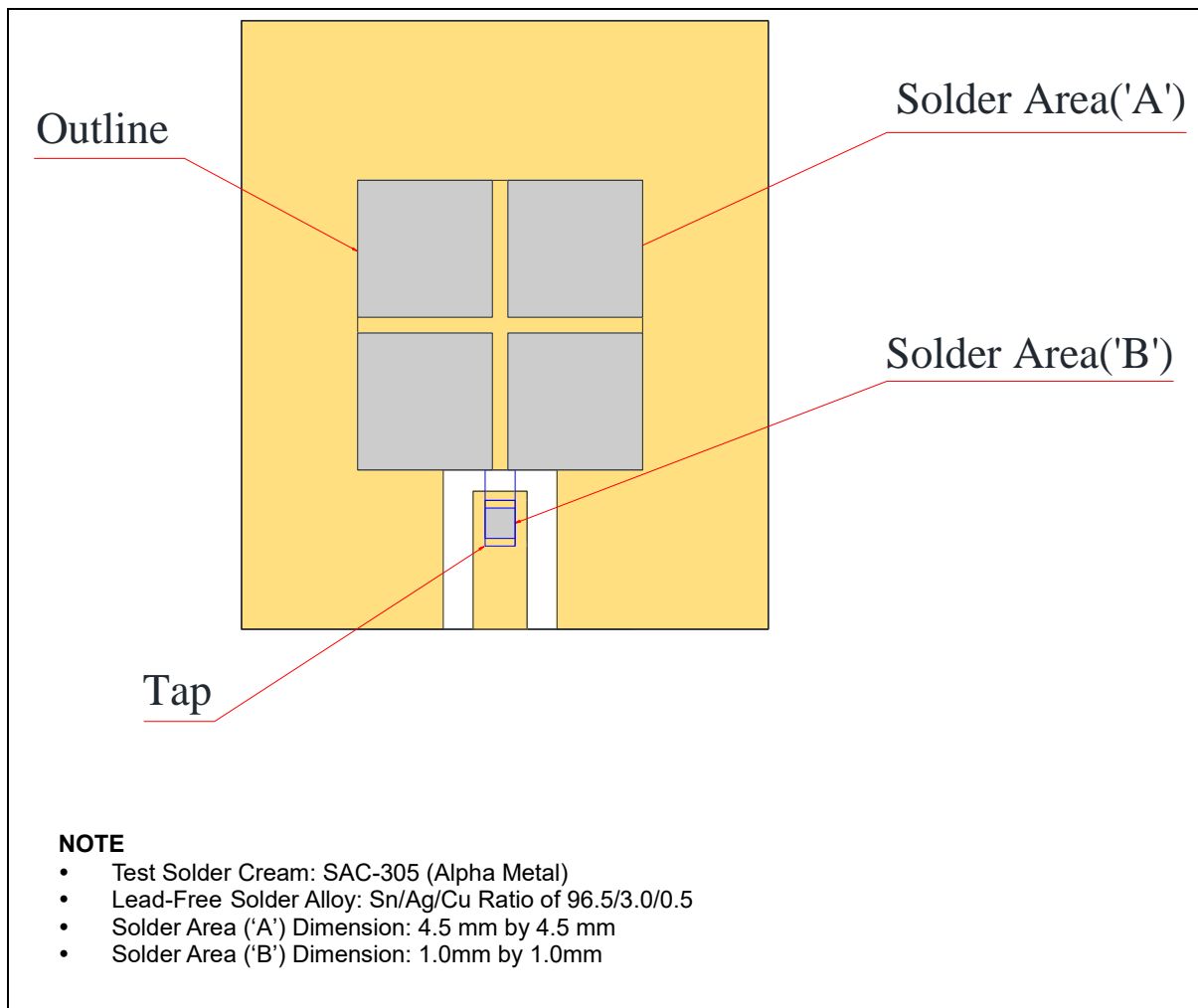

**Figure 6. Recommended PCB Layout and Solder Mask Pattern**

## SOLDERING PROCESS

The V3737NB soldering steps are as follows:

1. Cleaning the PCB
2. Applying solder paste to the PCB
3. Placing the V3737NB on the PCB
4. Reflowing the V3737NB to the PCB
5. Cleaning and inspecting the soldered PCB with the V3737NB

### STEP 1: Cleaning the PCB

Carefully clean the PCB surface where the V3737NB is soldered.

Particles must not be placed on the PCB surface where the V3737NB is soldered.

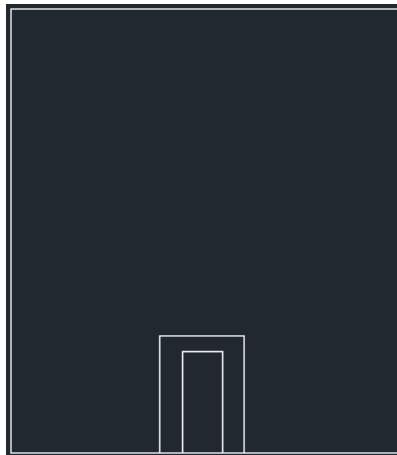

Figure 7. Cleaning the PCB Surface Where the V3737NB is soldered

### STEP 2: Applying the Solder Paste to the PCB

Apply the solder paste to the 5 points on the PCB surface.

It enables good thermal conductivity because the V3737NB is firmly attached to the PCB surface without air.

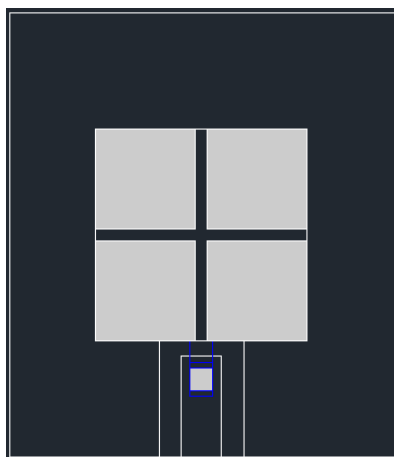

Figure 8. Applying the Solder Paste to the 5 Points on the PCB Surface

### STEP 3: Placing the V3737NB on the PCB

Correctly place the V3737NB on the 5 points of the PCB surface. Applying the solder paste to the 5 points helps you firmly attach the V3737NB to the PCB surface.

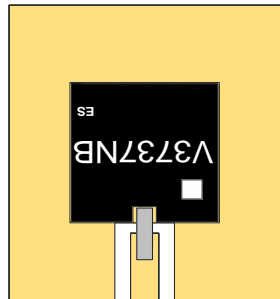

Figure 9. Placing the V3737NB on the 5 Points of the PCB Surface

### STEP 4: Reflowing the V3737NB to the PCB

We recommend both manual soldering and PCB surface pre-heating methods when reflowing the V3737NB to the PCB surface. Be careful NOT to touch the iron tip to the V3737NB when you use the manual soldering method. See [REFLOW PROFILE](#) for more details.

## REFLOW PROFILE

Figure 12 shows the thermal reflow profile of the SAC-305 (Alpha metal), which is a test solder cream we used.

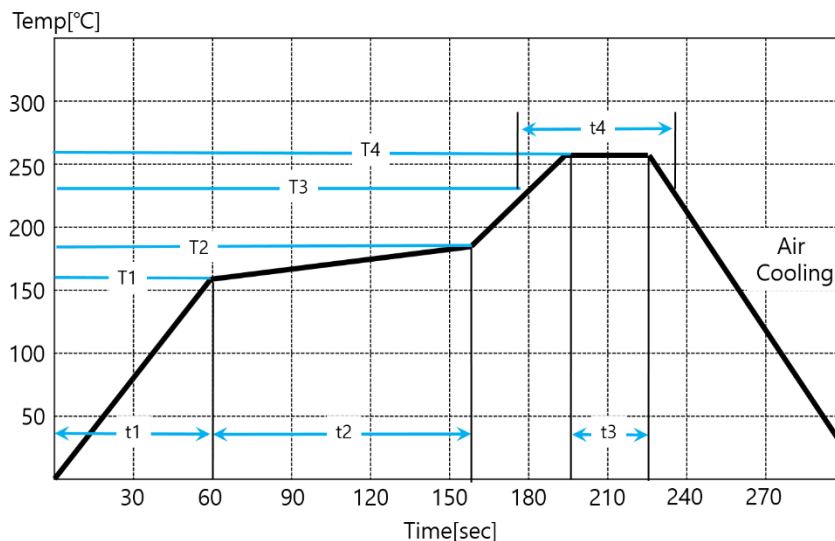
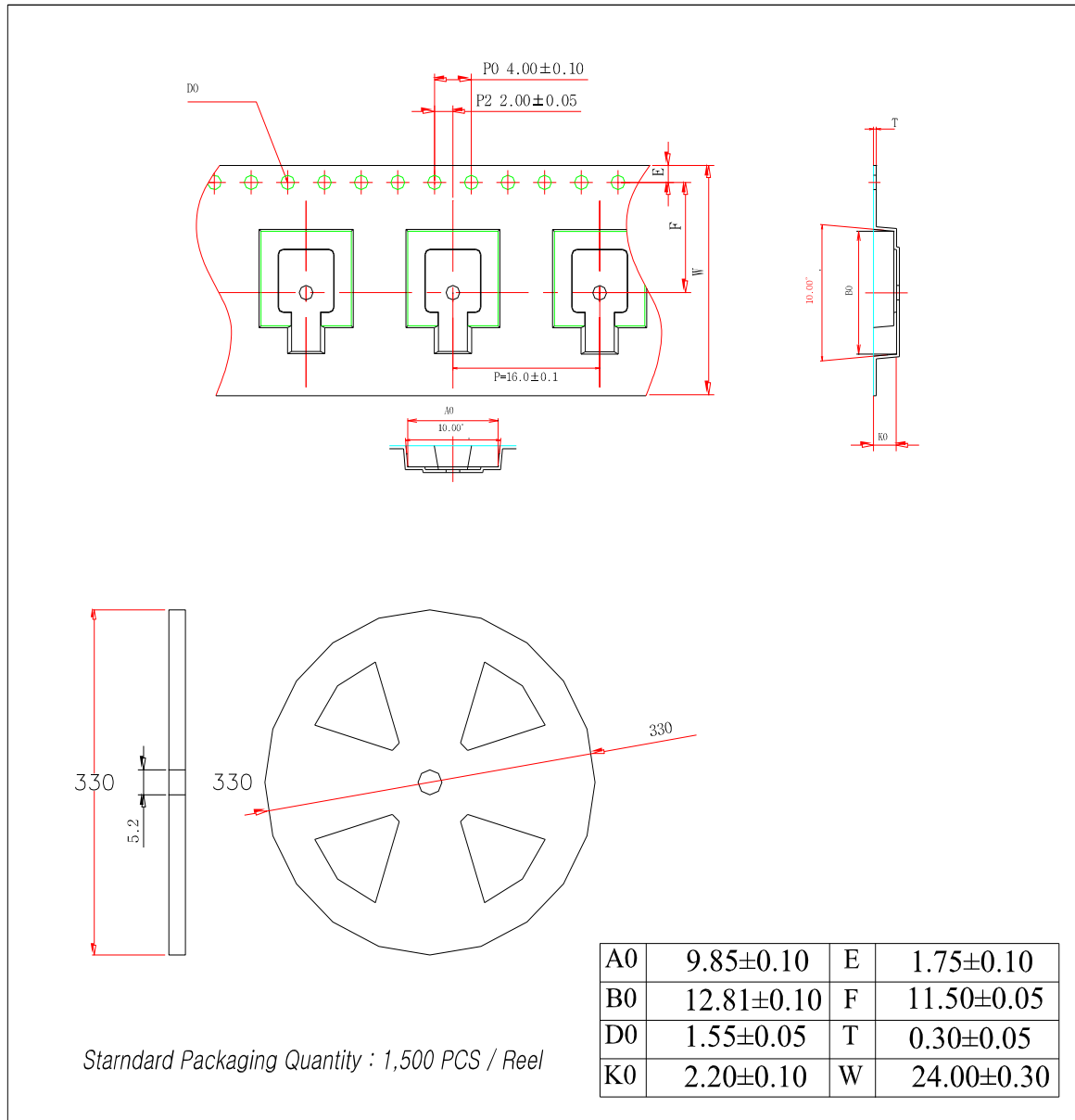

Figure 10. Thermal Reflow Profile

	Ramp Up	Pre-Heating	Peak	Soaking
Temperature(□)	T1:160±5°C	T2:180±5°C	T4:260±5°C	T3:230±5°C
Time(sec)	t1:60±5sec	t2:100±15sec	t3:30±5sec	t4:60±10sec

## PACKAGING AND ORDERING INFORMATION



## CAUTION

PLEASE READ THIS NOTICE BEFORE USING OUR TERMINATION.

### I. Be careful when transporting

- Ensure proper transportation as excessive stress or shock may damage Termination due to the nature of ceramics structure.
- Terminations cracked or damaged on terminals may have their property changed.

### II. Be careful during storage

- Store Termination in the temperature of -55°C to +125°C.
- Keep the humidity at 45% to 75% around Termination.
- Prevent corrosive gas (Cl<sub>2</sub>, NH<sub>3</sub>, SO<sub>x</sub>, NO<sub>x</sub>, etc.) from contacting Terminations.
- It is recommended to use Termination within 6 months of receipt. If the period exceeds 6 months, solderability may need to be verified.

### III. Be careful when soldering

- Solder all the ground terminals, IN pad of Termination on the ground plane of the PCB.
- Termination may be cracked or broken by uneven forces from a claw or suction device.
- Mechanical stress by any other devices may damage Termination when positioning them on PCB.
- Do not use dropped Termination.
- Ensure that any soldering is carried out by the condition of specification sheet.
- Do not re-use Termination which are de-soldered from PCB.

## LEGAL INFORMATION

Information in this document is believed to be accurate and reliable. However, RN2 Technologies does not give any representations or warranties, expressed or implied, as to the accuracy or completeness of such information and shall have no liability for the consequences of use of such information. RN2 Technologies does not take any responsibility for the content in this document if provided by an information source outside of RN2 Technologies.

RN2 Technologies reserves the right to make changes to information published in this document, including without limitation specifications and product descriptions, at any time and without notice. This document supersedes and replaces all information supplied prior to the publication hereof.

RN2 Technologies products are not authorized for use in safety-critical applications (such as life support) where a failure of the RN2 Technologies products would reasonably be expected to cause severe personal injury or death, unless officers of the parties have executed an agreement specifically governing such use. Buyers represent that they have all necessary expertise in the safety and regulatory ramifications of their applications, and acknowledge and agree that they are solely responsible for all legal, regulatory and safety-related requirements concerning their products and any use of RN2 Technologies products in such safety-critical applications, notwithstanding any applications-related information or support that may be provided by RN2 Technologies. Further, Buyers must fully indemnify RN2 Technologies and its representatives against any damages arising out of the use of RN2 Technologies products in such safety-critical applications.

RN2 Technologies does not accept any liability related to any default, damage, costs or problem which is based on any weakness or default in the customer's applications or products. Customer is responsible for doing all necessary testing for the customer's applications or products using RN2 Technologies products in order to avoid a default of the applications and the products. RN2 Technologies does not accept any liability in this respect.

**RN2 Technologies**

For more information, refer to:

**[HTTP://WWW.RN2.CO.KR/](http://www.rn2.co.kr/)**